

Motors

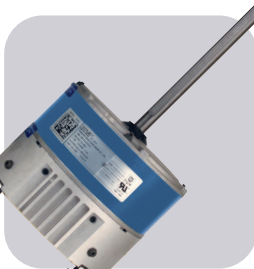

Table of Contents

MARS Motors Page No.

HVAC Motors:

Azure® ECM, Direct Drive.....	M-3
Azure® ECM, Condenser Fan.....	M-4
Azure® ECM, 3.3" Commercial Refrigeration	M-4
Azure® ECM, Commercial Refrigeration Watt Motor	M-5
Azure® Accessories	M-4, M-5
60°C Condenser Fan Motors.....	M-6
60°C Condenser Fan Motors (Shaft Up Only)	M-7
60°C Condenser Fan Motors (3 Wire)	M-7
70°C Condenser Fan Motors (208-230V).....	M-8
80°C Condenser Fan Motors (208-230V).....	M-8
Multi-HP 60°C Condenser Fan Motors	M-9
Multi-HP 70°C Condenser Fan Motors	M-9
70°C Condenser Fan Motors (460V).....	M-10
70°C Condenser Fan Motors Shaft Up Only (460V)	M-10
Super-Fit™ Multi-HP 42 Frame Condenser Fan Motors	M-11
Direct Drive Blower Motors.....	M-12
Direct Drive Torsion Flex Mount Motors	M-13
Multi-HP Direct Drive Blower Motors	M-13
Direct Drive Blower Motors (460V).....	M-13
Belted Fan and Blower Motors.....	M-14, M-15
Commercial Condenser Fan Motors Three Phase.....	M-15 – M-16
Unit Heater Motors	M-16
Oil Burner Motors	M-17
51 Frame Unit Bearing Motors	M-17 – M-18
Draft Inducer Blower Motors.....	M-20

Refrigeration Motors:

Azure® ECM, 3.3" Commercial Refrigeration	M-4
Azure® Watt Motor	M-4
Unit Bearing Motors	M-17-M-18, M-36
Super-Fit™ C Frame Replacement Motors.....	M-28 – M-19
3.3" Commercial Refrigeration Motors	M-19-M-20
One-On-One™ Direct Replacement Motors	M-21
One-On-One™ Direct Replacement Motors for Copeland.....	M-21
11 Frame Unit Bearing Motor	M-37

Cross Reference:.....M-22 – M-27

JARD Motors Page No.

Refrigeration Motors:

Unit Bearing Motors.....	M-28
--------------------------	------

HVAC Motors:

Condenser Fan Motors.....	M-28
Direct Drive Blower Motors.....	M-29
Multi-HP Direct Drive Blower Motors.....	M-29, M-30, M-31
Multi-HP Condenser Fan Motors	M-31

Cross Reference:.....M-31

EM&S Motors Page No.

Refrigeration Motors:

Unit Bearing Motors	M-32-M-34
ECM 51 Frame	M-34, M-35
ECM Fan Motor/Motor System.....	M-34, M-35
PSC Type Replacement for GE.....	M-36
Copeland OEM Direct Replacement Motors	M-36

Morrill Page No.

Refrigeration Motors:

Arctic 59	M-35
Tyler Refrigeration OEM Direct Replacement Motors	M-36

Elco Page No.

Refrigeration Motors:

NU Series Shaded Pole Motors	M-37
ECM High Efficiency Motors	M-38

Genteq Page No.

Refrigeration Motors:

5KCP29-Form G PSC Motors	M-38
--------------------------------	------

HVAC Motors:

Vertical Shaft Down Condenser Fan and Heat Pump Motors	M-39
Multi-HP Direct Drive Blower Motors	M-39
Multi-HP Condenser Fan Motors.....	M-40
Condenser Fan Motors Shaft Up/Down	M-40, M-41
Condenser Fan Motors Shaft Up.....	M-41
Condenser Fan Motors (460V).....	M-41
Direct Drive Blower Motors (460V).....	M-42
Direct Drive Blower Motors.....	M-42
Direct Drive PSC Torsion Flex Mount Motors.....	M-43
Double Shaft and Fan Blower Motors	M-43

Motor Accessories Page No.

TECMate Pro™ Service Tool	M-44
Motor Speed Controllers	M-44
ECM Protectors	M-44
ECM Repair Kit.....	M-44
Variable Speed Zebra.....	M-45
Universal Zebra	M-45
Motor Mounting Bases	M-45
Vibration Insulators.....	M-45
Plastic Rain Shields.....	M-45
Mounting Brackets.....	M-46
Belly Bands	M-46

Azure[®] ECM

Direct Drive Blower Applications

Ball Bearing

Azure[®] ECM from MARS is a high efficiency variable speed direct drive blower motor for a multitude of applications. Azure[®] is a replacement for both standard PSC and Constant Torque motors. These motors cover ratings from 1/5 HP to 1 HP at 115V or 230V and CW or CCW.

Azure[®] features an auto sizing learn mode. In start-up learn mode, Azure[®] runs for approximately 2 minutes measuring the external static pressure of the system application. Azure[®] then assigns torque values to each of its speed taps self-programming itself to the correct horsepower for the application.

If none of the four speeds provides perfect airflow for the application or if duplicate speeds are desired on 2 or more taps, an optional hand held programmer (MARS No. 08502) can be used. The programmer connects to Azure[®] and displays the percentage of torque applied to the speed tap being energized. The percentage (motor speed) can then be increased or decreased and permanently set with the programmer. This tool overrides the motor torques established in the auto sizing mode. Unlike other electronically commutated motors, an outboard surge protector is included within Azure's[®] wire harness. This is a replaceable device (MARS No. 08593).

Features:

- Outboard replaceable surge protector
- Adjustable speeds (with optional MARS No. 08502)
- 4 speeds plus 625 RPM constant fan mode
- High efficiency 85%
- Multi-horsepower, dual voltage
- Belly band mount

Specifications:

- Class "B" insulation
- Thermal overload protected
- Operating temperature range: -20°C to 55°C (-4°F to 131°F)
- UL Recognized
- For accessories see page M-5

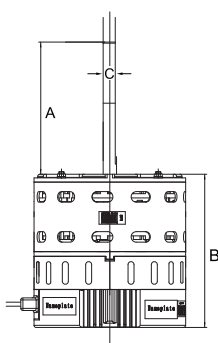
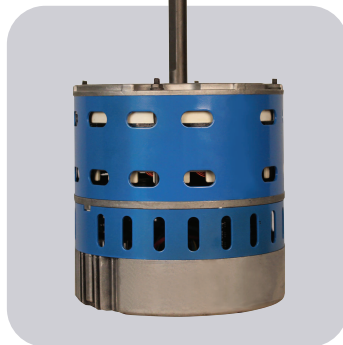

MARS No.	External Surge Protection	Auto-Sizing	Replaces
10860	Yes	Yes	PSC/Constant Torque
10861	Yes	Yes	PSC/Constant Torque
10865	No	No	PSC
10866	No	No	PSC
10867	No	No	PSC

MARS NO.	HP	VOLTS	RPM	ROTATION	DIAMETER	DIMENSIONS		
						A	B	C
10860	1/5-1/2	115/230	1075	Rev	5-1/2	4.93	5.72	1/2
10861	1/2-1	115/230	1075	Rev	5-1/2	4.93	6.66	1/2
10865	1/3-1/2	115/230	1075	Rev	5-1/2	4.93	5.72	1/2
10866	3/4-1	115/230	1075	Rev	5-1/2	4.93	6.66	1/2
10867	1/8-1/3	115/230/277	1075	Rev	5	5.00	5.00	1/2

Azure[®] ECM

Direct Drive Blower Applications Bluetooth

Ball Bearing

The latest generation of Azure[®] ECM features integrated Bluetooth control for use with the Azure[®] ECM smartphone app. While not required for the installation of these motors, the app allows the installer to take full advantage of the ECM technology. While competitive aftermarket ECMs provide only 5 speed taps for setting airflow, the Bluetooth Azure[®] motors provide more than 50 speed selections and the ability to autosize to the ductwork all with a keystroke or two in the app..

One Touch Autosizing

One touch of a button automatically assigns correct torque for the ductwork; additional programming harnesses are not required.

Individual Speed Tap Adjustments

Dial in the temperature rise with 1% torque increments. Tune out annoying high frequency harmonics. Optimize CFM.

Real Time Data

Monitor motor volts, amps, watts, and RPM's.

Drop-in Installation

Simple to wire; connections are the same as the motor being replaced.

Features:

- 4 speeds plus 625 RPM constant fan mode
- High efficiency 85%
- Multi-horsepower, dual voltage
- Belly band mount

Specifications:

- Class "B" insulation
- Thermal overload protected
- Operating temperature range: -20°C to 55°C (-4°F to 131°F)
- UL Recognized
- For accessories see page M-5

MARS No.	Adjustable Speeds*	Auto-Sizing*	Replaces
10858	Yes	Yes	Constant Torque, Ensite, Endura
10859	Yes	Yes	Constant Torque, Ensite, Endura

* When Azure[®] Blower Motor App is used

MARS NO.	HP	VOLTS	RPM	ROTATION	DIAMETER	DIMENSIONS		
						A	B	C
10858	1/5 - 1/2	115/230	1075	Rev	5-1/2	4.93	5.72	1/2
10859	1/2 - 1	115/230	1075	Rev	5-1/2	4.93	6.66	1/2

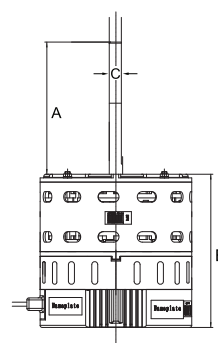
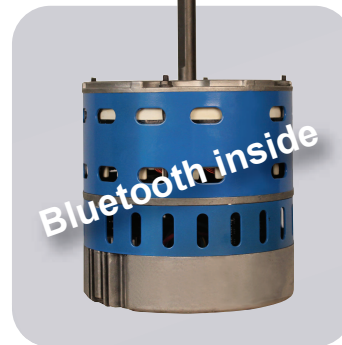

Azure[®] ECM

**Condenser Fan Applications
Ball Bearing**

Azure[®] is an electronically controlled motor (ECM) that replaces a multitude of applications. These motors cover ratings from 1/8 HP to 1/3 HP at 208-230V 825/1075 RPM and 1/3 HP to 1/2 HP 208-230V 825/1075 RPM and CW or CCW. These motors are simple to install. The Azure[®] condenser fan motors connect the same as a standard PSC condenser fan motor, BUT WITHOUT the capacitor. Just plug the motor into a 115V power source (using supplied programming cable) and select 1 of 4 operating modes and then install the motor:

- 1) 1075 RPM CW (LE) - Factory Default
- 2) 1075 RPM CCW (LE)
- 3) 825 RPM CW (LE)
- 4) 825 RPM CCW (LE)

Unlike other ECM motors, an outboard surge protector is included with the Azure[®] wiring harness. This is a replaceable device that is much less expensive to replace than replacing the entire motor in the event of a power surge.

Specifications:

- Multi horsepower, self-adjusting
- 825/1075 RPM, single speed
- Reversible rotation
- High efficiency ECM
- No capacitor required
- Water slinger on shaft
- UL Recognized
- For accessories see page M-5

MARS NO.	HP	VOLTS	RPM	ROTATION	ORIENTATION	RHEEM HOLES	DIMENSIONS		
							A	B	C
10874	1/8 - 1/3	208-230	825/1075	Rev	Shaft Down	Yes	6.50	4.33	1/2
10875	1/8 - 1/3	208-230	1075	Rev	Horizontal	No	6.50	4.33	1/2
10872	1/3 - 1/2	208-230	1075	Rev	Horizontal	No	6.00	5.95	1/2

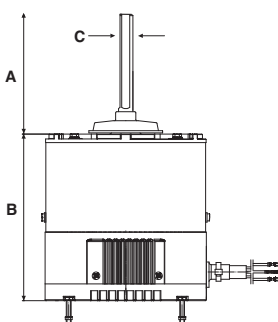

Azure[®] ECM

**3.3" Commercial Refrigeration
Evaporator Fan Motor
Ball Bearing**

Azure[®] is an electronically controlled 3.3" motor (ECM) that replaces all 1/15 - 1/25 HP, 115/230V, and 1550/600 RPM commercial refrigeration evaporator fan motors for walk in cooler/freezer applications. For 1550 RPM, this motor connects easily to the fan controller via a standard Lyall plug. For 2-speed applications, the Lyall plug can be removed and the motor can be wired directly to a separate 2-speed control module using the included second speed tap for 600 RPM. Motor rotation is set using a simple jumper wire. Azure[®] is rated for 115V or 230V with nothing to set; plug it in to either voltage and it adapts to the correct voltage.

Specifications:

- Operating temperature range: -40° to 131°F
- Multi horsepower, self adjusting from 1/15 to 1/25HP
- Reversible rotation
- Auto voltage select (115/230V)
- High efficiency ECM technology
- No capacitor required
- UL Recognized
- For accessories see page M-5

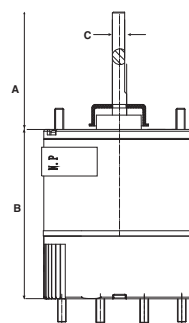

MARS NO.	HP	VOLTS	RPM	SPEEDS	ROTATION	DIMENSIONS		
						A	B	C
10850	1/15 - 1/25	115/230	1550	1	Rev	2.5	3.74	5/16
10852	1/15 - 1/25	115/230	1550 ⁽¹⁾	1 or 2 ⁽²⁾	CCWLE ⁽³⁾	2.5	3.74	5/16

- (1) 1550 default; adjustable 600-2000 RPM with optional wireless programmer kit (MARS No. 08505)
- (2) 2-speeds attainable with optional wireless programmer (MARS No. 08505) and optional thermistor kit (MARS No. 08515)
- (3) CCWLE default; reversible with optional wireless programmer (MARS No. 08505)

Azure[®] Variable Speed Motor Adapter

The Azure[®] Variable Speed Motor Adapter is a money saving solution to the expensive replacement of a failed OEM variable speed blower motor using an Azure[®] ECM motor. Simply move the OEM wire harnesses to the Azure[®] Variable Speed Adapter and connect the Azure[®] direct drive motor speed taps to the Azure[®] Variable Speed Adapter.

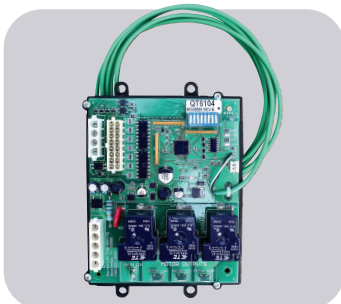

- Allows replacement of 2.0, 2.3, 2.5, and 3.0 variable speed communicating ECM motors
- Allows replacement of variable speed communicating ECM motors from Nidec / US Motors, and Emerson
- Eliminates wasted time & money locating OEM motor
- Allows replacement of all variable speed direct drive ECM 115V / 230V 1/3, 1/2, 3/4, 1HP (not for use to replace X13 style constant torque ECM)

MARS NO.	DESCRIPTION	AZURE [®] MOTOR COMPATIBILITY
08506	Variable Speed Motor Adapter	10865, 10866

AZURE® ECM

Commercial Refrigeration Watt (Reach-In) Motor Ball Bearing

MARS ECM watt motor is a Drop in replacement for most OEM / ECM / PSC and standard shaded pole commercial refrigeration evaporator and condenser fan motors. Capable of replacing most 1550 RPM case motors 4 - 25W for reach-in cooler/freezer applications. The microprocessor sets power output to match the fan load ensuring correct CFM and maximum efficiency in every installation. Automatically senses and adapts to the system voltage (115/230V). MARS No. 10891 - Wirelessly Programmable. Download Azure® ECM App to your smart phone/tablet.

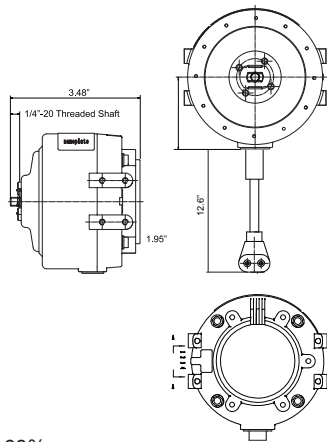

Specifications:

- Submersible - IP67
- Operating temperature range: -40° to 131°F
- Self adjusting from 4 to 25 Watts
- 1550⁽¹⁾ RPM
- CWLE⁽³⁾ Rotation
- Auto Voltage Select (115/230V)
- High efficiency ECM technology: 68%
- Estimated Energy Savings: \$33/year (\$46/year total)⁽²⁾
- 90° Angle Lyall Plug
- Water Resistant: Yes
- UL Recognized
- For accessories see page M-5

Fan Load	Power Consumption	
	Standard Motor Power Consumption	Azure® Power Consumption
4 W	28 W	6 W
9 W	47 W	14 W
16 W	77 W	30 W

MARS NO.	WATTS OUTPUT	VOLTS	RPM	ROTATION	LEAD LENGTH
10891	4 - 25	115/230	1550 ⁽¹⁾	CWLE ⁽³⁾	13"

⁽¹⁾ 1550 default; adjustable 600-2000 RPM with optional wireless programmer kit (MARS No. 08505)
⁽²⁾ Estimated energy savings based on replacement of a 9W shaded pole evaporator fan motor with Azure® at \$0.11/kWh. \$33 savings is based solely on the reduction of power consumption. An additional savings of approximately 40% will result from the reduction of the refrigeration load due to Azure®'s lower operating temperature.
⁽³⁾ CWLE default; reversible with optional wireless programmer kit (MARS No.08505)

Accessories for Azure® ECM

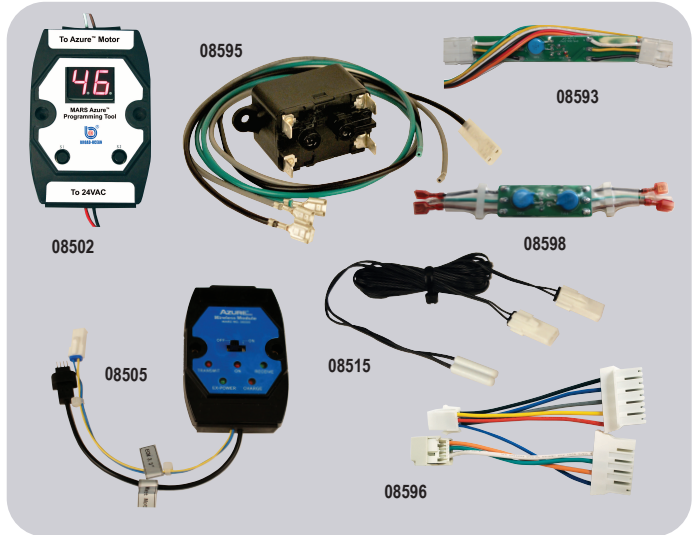

MARS NO.	DESCRIPTION
08502	Hand Held Programmer 10860/10861/10865/10866/10867/10868/10869
08593	Replacement Surge Protector 10860/10861
08595	Constant Fan Kit 10858/10859/10860/10861/10865/10866
08598	Replacement Surge Protector 10872/10874/10875
08505	Wireless Programmer Kit; Requires Azure ECM® App and Smart Device (sold separately) for 10891/10852
08515	Thermistor Kit for 2-Speed Operation (2/PK) for 10852; Controls up to 5 Motors
08596	Onsite Adapter: Accessory 10856, 10857 Replacement Part 10858, 10859

Tech Tip

All ECM motors are more energy efficient than standard motors even though the amp draw may be similar. ECM motors have lower power factors and thus consume fewer watts. Power Consumption (Watts) = Volts x Amps x Power Factor.

Condenser Fan Motors

Outdoor Condenser Fan Motors

Ball Bearing

MARS all angle outdoor condenser fan motors are designed for either shaft-up or shaft-down applications. End shields are enclosed for weather protection. A weep hole is provided in each end shield to allow condensate to drain. All of these motors are suitable for air conditioning or heat pump applications.

Features:

- All angle
- Rheem mounting holes w/screws installed
- Water slinger on shaft
- Thru bolt or band mounting
- Capacitor requirement noted on motor label
- Double full flatted shaft

Specifications:

- Class "B" insulation
- Single phase, 60 Hertz
- Thermal overload protected
- Fan duty, continuous, air over
- Totally enclosed
- 36 inch leads
- UL Recognized

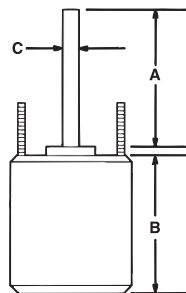

Outdoor Condenser Fan Motors

Ball Bearing

MARS up/down outdoor condenser fan motors are designed for either vertical shaft-up or shaft-down applications. Shell and end shields are enclosed for weather protection. A weep hole is provided in each end shield to allow condensate to drain. All of these motors are suitable for air conditioning or heat pump applications.

Features:

- All angle
- Rheem mounting holes w/screws installed
- Water slinger on shaft
- Thru-bolt or band mounting
- Capacitor requirement noted on motor label
- Extra set of nuts & star washers on mounting studs
- Double full flatted shaft

Specifications:

- Class "B" insulation
- Single phase, 60 hertz
- Thermal overload protected
- Totally enclosed
- 36 inch leads
- UL Recognized

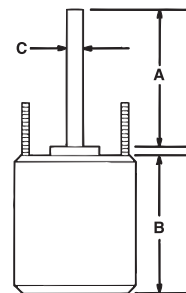

Reversible Rotation – Single Speed

MARS NO.	HP	VOLTS	AMPS	CAP REQ.	ENCL.	BRG.	DIMENSIONS		
							A	B	C
1075 RPM									
10725	1/8	208-230	0.72	5/370	TEAO	Ball	6.50	4.12	1/2
10727	1/6	208-230	0.90	5/370	TEAO	Ball	6.50	4.23	1/2
10726	1/5	208-230	1.17	5/370	TEAO	Ball	6.50	4.12	1/2
10728	1/4	208-230	1.8	5/370	TEAO	Ball	6.50	4.23	1/2
10729	1/3	208-230	2.4	7.5/370	TEAO	Ball	6.50	5.23	1/2
10730	1/2	208-230	3.5	10/370	TEAO	Ball	6.50	5.73	1/2
10731	3/4	208-230	5.2	10/370	TEAO	Ball	6.50	6.23	1/2

MARS NO.	HP	VOLTS	AMPS	CAP REQ.	ENCL.	BRG.	DIMENSIONS		
							A	B	C
825 RPM									
10411	1/8	208-230	0.80	5/370	TEAO	Ball	6.50	4.13	1/2
10403	1/6	208-230	1.0	5/370	TEAO	Ball	6.50	4.23	1/2
10412	1/5	208-230	1.3	5/370	TEAO	Ball	6.50	4.40	1/2
10404	1/4	208-230	1.6	5/370	TEAO	Ball	6.50	4.48	1/2
10405	1/3	208-230	1.9	7.5/370	TEAO	Ball	6.50	5.23	1/2
10746	1/2	208-230	2.8	12.5/370	TEAO	Ball	6.50	5.70	1/2

Reversible Rotation – Single Speed

MARS NO.	HP	VOLTS	AMPS	RPM	CAP REQ.	DIMENSIONS		
						A	B	C
1075 RPM								
10732	1/6	208-230	0.90	1075	5/370	6.50	4.13	1/2
10733	1/4	208-230	1.8	1075	5/370	6.50	4.25	1/2
10734	1/3	208-230	2.4	1075	7.5/370	6.50	5.10	1/2
10735	1/2	208-230	3.5	1075	10/370	6.50	5.70	1/2
10736	3/4	208-230	5.2	1075	10/370	6.50	5.11	1/2

MARS NO.	HP	VOLTS	AMPS	RPM	CAP REQ.	DIMENSIONS		
						A	B	C
825 RPM								
10203	1/6	208-230	1.0	825	5/370	5.50	4.10	1/2
10204	1/4	208-230	1.6	825	5/370	5.50	4.40	1/2
10205	1/3	208-230	1.9	825	7.5/370	5.50	5.10	1/2
10747	1/2	208-230	2.8	825	12.5/370	6.50	5.70	1/2

Outdoor Condenser Fan Motors - Shaft Up Only

MARS outdoor condenser fan motors are designed for shaft up only used in condenser fan and heat pump units requiring vertical shaft up positioning with "belly band" or extended clamp screw mounting.

Features:

- Rheem mounting holes w/screws installed
- For shaft up application
- Reversible rotation
- Water slinger on shaft
- Full flatted six inch shaft length
- Capacitor requirement noted on motor label

Specifications:

- Class "B" insulation
- Single phase, 60/50 Hertz
- Automatic thermal overload protected
- Fan duty, continuous, air over
- 36 inch leads
- Lead end endshield open construction
- UL Recognized

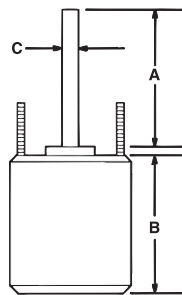

MARS Three Wire Condenser Fan Motors

Ball Bearing

MARS 3 Wire condenser fan motors replicate OEM wiring for condenser fan motors speeding installation and saving time.

Condenser fan motors are designed for either shaft-up or shaft-down applications. End shields are enclosed for weather protection. A weep hole is provided in each end shield to allow condensate to drain. All of these motors are suitable for air conditioning or heat pump applications.



Features:

- All angle, ball bearing
- Rheem mounting holes w/screws installed
- Water slinger on shaft
- Thru bolt or band mounting
- Capacitor requirement noted on motor label
- Double full flatted shaft

Specifications:

- Class "B" insulation
- Single phase, 60 Hertz
- Thermal overload protected
- Fan duty, continuous, air over
- Totally enclosed
- 36 inch leads
- UL Recognized

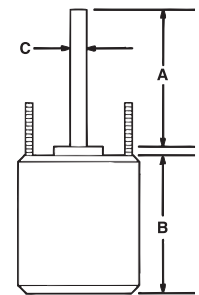

1075 RPM – Shaft-Up – Single Speed

MARS NO.	HP	VOLTS	AMPS	ROTATION	CAP REQ.	BRG.	DIMENSIONS		
							A	B	C
10327	1/6	208-230	0.9	REV	5/370	Sleeve	6.0	4.15	1/2
10328	1/4	208-230	1.8	REV	5/370	Sleeve	6.0	4.15	1/2
10329	1/3	208-230	2.4	REV	7.5/370	Sleeve	6.0	5.11	1/2
10330	1/2	208-230	3.5	REV	10/370	Ball	6.0	5.70	1/2
10331	3/4	208-230	5.2	REV	10/370	Sleeve	6.0	6.09	1/2

Reversible Rotation – Single Speed – 3 Wire

MARS NO.	HP	VOLTS	AMPS	CAP REQ.	ENCL.	BRG.	DIMENSIONS		
							A	B	C
1075 RPM									
23728	1/4	208-230	1.8	5/370	TEAO	Ball	6.50	4.23	1/2
23729	1/3	208-230	2.4	7.5/370	TEAO	Ball	6.50	5.23	1/2

Condenser Fan Motors

Outdoor Condenser Fan Motors

Ball Bearing - 70°C

MARS 70°C SunSlinger totally enclosed condenser fan motors are designed for either vertical shaft-up or shaft-down applications in a variety of ambient conditions. Shell and end shields are enclosed for weather protection. A weep hole is provided in each end shield to allow condensate to drain. All of these motors are suitable for air conditioning or heat pump applications.

Features:

- All angle
- Rheem mounting holes w/screws installed
- Trane 4.33 bolt circle mounting holes with self tapping screws
- Thru bolt or band mounting
- Water slinger on shaft
- Capacitor requirement noted on motor label
- Extra set of nuts on mounting studs

Specifications:

- Class "B" insulation
- Single phase, 60 Hertz
- 70°C/158°F
- Thermal overload protected
- Fan duty, continuous, air over
- Totally enclosed
- 36 inch leads
- UL Recognized

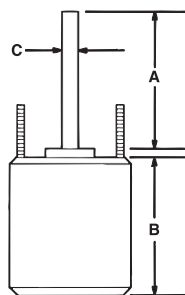

Reversible Rotation – Single Speed

MARS NO.	HP	VOLTS	AMPS	CAP REQ.	ENCL.	DIMENSIONS		
						A	B	C
1075 RPM								
20727	1/6	208-230	0.90	5/370	TEAO	6.50	4.25	1/2
20728	1/4	208-230	1.8	5/370	TEAO	6.50	4.72	1/2
20729	1/3	208-230	2.4	7.5/370	TEAO	6.50	5.24	1/2
20730	1/2	208-230	3.5	10/370	TEAO	6.50	5.91	1/2
20731	3/4	208-230	5.2	10/370	TEAO	6.50	5.90	1/2

MARS NO.	HP	VOLTS	AMPS	CAP REQ.	ENCL.	DIMENSIONS		
						A	B	C
825 RPM								
20402	1/8	208-230	0.75	5/370	TEAO	6.50	4.30	1/2
20403	1/6	208-230	1.0	5/370	TEAO	6.50	4.52	1/2
20404	1/4	208-230	2.2	5/370	TEAO	6.50	4.92	1/2
20405	1/3	208-230	1.9	7.5/370	TEAO	6.50	5.31	1/2
20746	1/2	208-230	2.8	12.5/370	TEAO	7.00	5.90	1/2

Outdoor Condenser Fan Motors

Ball Bearing - 80°C

MARS 80°C SunSlinger Max totally enclosed condenser fan replacement motors are designed for all major brands of HVAC equipment applications in a variety of ambient conditions. These 48 frame motors offer the highest performance and available from 1/6HP thru 3/4HP, 1075 RPM and 825 RPM, and 208-230V.

Features:

- All angle
- Rheem mounting holes w/screws installed
- Trane 4.33 bolt circle mounting holes with self tapping screws
- Thru bolt or belly band mounting
- Water slinger on shaft
- Capacitor requirement noted on motor label
- Extra set of nuts on mounting studs

Specifications:

- Class "F" insulation
- Single phase, 60 Hz
- 80°C (176°F) max ambient
- Thermal overload protection
- Fan duty, continuous, air over
- Totally enclosed
- 36 inch leads
- UL Recognized

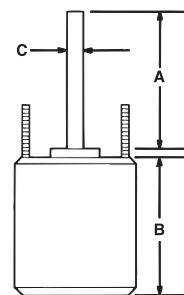

Reversible Rotation

MARS NO.	HP	VOLTS	AMPS	RPM	CAP REQ.	ENCL.	DIMENSIONS		
							A	B	C
1075 RPM									
20791	3/4	208-230	4.5	1075	10/370	TEAO	6.50	6.50	1/2
825 RPM									
20796	1/2	208-230	2.8	825	12.5/370	TEAO	7.00	6.42	1/2

Multi-Horsepower Condenser Fan Motors

Ball Bearing

MARS multi-horsepower condenser fan motors are ideal for truck stock. Three 1075 RPM models cover 208-230 volt applications from 1/6 to 1/2 HP. Two 825 RPM models cover 208-230 volt applications from 1/8 to 1/3 HP.

Features:

- Rheem mounting holes w/screws installed
- Thru bolt or band mounting
- Water slinger on shaft
- Air conditioning or heat pump duty

Specifications:

- Class "B" insulation
- Single phase, 60 Hz
- Thermal overload protected
- UL Recognized

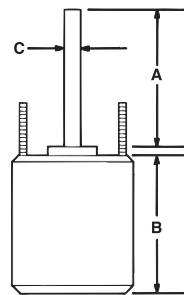

Multi-Horsepower Condenser Fan Motors

Ball Bearing - 70°C

MARS 70°C multi-horsepower SunSlinger condenser fan motors are ideal for truck stock. They are designed to provide reliable operation in a wide range of ambient temperatures. Three 1075 RPM models cover 208-230 volt applications from 1/6 to 1/2 HP. Two 825 RPM models cover 208-230 volt applications from 1/8 to 1/3 HP.

Features:

- All angle
- Rheem shell mounting holes with screws installed
- Trane 4.33 bolt circle mounting holes with self tapping screws
- Thru bolt or band mounting
- Water slinger on shaft
- Extra set of nuts on mounting studs

Specifications:

- Class "B" insulation
- Single phase, 60 Hertz
- 70°C/158°F
- 36 inch leads
- Thermal overload protected
- Fan duty, continuous, air over
- Totally enclosed
- UL Recognized

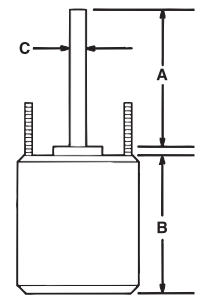

20458 & 20459:

- Short shell length
- Just ONE capacitor rating per motor
- Quick & Simple 2 wire installation

The Wiz

MARS NO.	HP	ROT	RPM/SP.	VOLTS	ENCL.	BRG.	DIMENSIONS			LEAD LENGTHS
							A	B	C	
10458	1/6 - 1/3	Rev	1075	208-230	TEAO	Ball	6.50	4.52	1/2	36"
10459	1/8 - 1/3	Rev	825	208-230	TEAO	Ball	6.50	5.48	1/2	36"
10465	1/6 - 1/3	Rev	1075/2	208-230	TEAO	Ball	5.00	4.73	1/2	38"
10468	1/5 - 1/2	Rev	1075/2	208-230	TEAO	Ball	5.00	5.48	1/2	38"
10469	1/6 - 1/3	Rev	825/2	208-230	TEAO	Ball	5.00	5.48	1/2	42"

Multi-Horsepower – Reversible Rotation

The Wiz

MARS NO.	HP	RPM/SPDS	VOLTS	AMPS	CAP REQ.	ENCL.	BRG.	DIMENSIONS		
								A	B	C
20458	1/6-1/3	1075	208-230	2.8	7.5/370	TEAO	Ball	6.50	5.00	1/2
20459	1/8-1/3	825	208-230	1.9	10/370	TEAO	Ball	6.50	5.71	1/2
20465	1/6-1/3	1075/2	208-230	2.5	5/7.5/370	TEAO	Ball	7.00	5.16	1/2
20468	1/5-1/2	1075/2	208-230	3.6	10/12.5/370	TEAO	Ball	5.00	6.10	1/2
20469	1/6-1/3	825/2	208-230	1.9	10/7.5/370	TEAO	Ball	5.00	6.10	1/2

One-On-One™ Replacement Motors

MARS NO.	HP	ROT	RPM/SPDS	VOLTS	AMPS	CAP REQ.	ENCL.	BRG.	DIMENSIONS		
									A	B	C
Emerson 5462H											
20462	1/3, 1/4, 1/5, 1/6	REV	1075/2	208-230	2.0	5/7.5/370	TEAO	Ball	5.00	4.91	1/2
Emerson 5482H											
20471	1/4, 1/3, 1/2, 3/4	REV	1075/2	208-230	4.2/3.6	15/440	TEAO	Ball	5.5	6.5	1/2
AO Smith FE6003F											
20470	1/4, 1/2	REV	825/2	208-230	2.6	10/12.5/440	TEAO	Ball	6.5	6.1	1/2
AO Smith ORM5854BF											
20457	1/8, 1/10, 1/12, 1/15	REV	825/1	208-230	0.75	5/440	TEAO	Ball	6.5	4.7	1/2
AO Smith ORM5454BF											
20463	1/8 - 1/15	REV	1075/1	208-230	0.65	5/440	TEAO	Ball	6.5	4.4	1/2

Condenser Fan Motors

MARS 460V Outdoor Condenser Fan Motors

Ball Bearing - 70°C

MARS 70°C SunSlinger totally enclosed outdoor condenser fan motors are designed for all angle air conditioning or heat pump applications. A weep hole is provided in each end shield to allow condensate to drain.

Features:

- All angle
- Rheem mounting holes w/screws installed
- Trane 4.33 bolt circle mounting holes and self tapping screws
- Extended thru bolt or band mounting and extra nuts
- Capacitor requirement noted on motor label
- Water slinger on shaft
- End shield drain holes w/plugs

Specifications:

- Single phase, 60 Hz
- 70°C/158°F
- Thermal overload protected
- Totally enclosed
- 48 inch leads, Multi-HP
- 36 inch leads
- UL Recognized

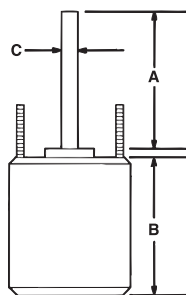

MARS 460V Outdoor Condenser Fan Motors – Shaft Up Only

Ball Bearing - 70°C

MARS 70°C SunSlinger totally enclosed outdoor condenser fan motors are designed for Shaft Up Only. All of these motors are suitable for air conditioning or heat pump applications. A weep hole is provided in each end shield to allow condensate to drain.

Features:

- Shaft up only
- Rheem mounting holes w/screws installed
- Extended thru bolt or band mounting
- Capacitor requirement noted on motor label

Specifications:

- Single Phase, 60 Hz
- 70°C/158°F
- Thermal overload protected
- Totally enclosed
- UL Recognized

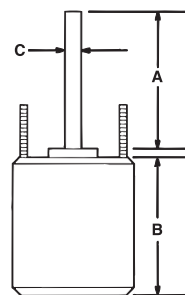

Reversible Rotation

MARS NO.	HP	VOLTS	AMPS	RPM	CAP REQ.	DIMENSIONS		
						A	B	C

1075 RPM - Single Speed

20835	1/6	460	0.48	1075	5/440	6.50	4.32	1/2
20836	1/4	460	0.65	1075	7.5/440	6.50	4.52	1/2
20837	1/3	460	0.90	1075	7.5/440	6.50	5.38	1/2
20838	1/2	460	1.3	1075	10/440	6.50	5.86	1/2
20842	3/4	460	2.0	1075	10/440	6.50	6.29	1/2

MARS NO.	HP	VOLTS	AMPS	RPM	CAP REQ.	DIMENSIONS		
						A	B	C

825 RPM - Single Speed

20859*	1/6	460	0.53	825	5/440	3.22	4.52	1/2
20880	1/4	460	0.90	825	5/440	6.50	5.00	1/2
20881	1/3	460	1.0	825	7.5/440	6.50	5.62	1/2
20882	1/2	460	1.55	825	10/440	6.50	6.34	1/2

MARS NO.	HP	VOLTS	AMPS	RPM	CAP REQ.	DIMENSIONS		
						A	B	C

1075 RPM - Multi-HP

20478	1/3 - 1/6	460	1.2	1075	7.5/370	6.50	4.90	1/2
20479	1/2 - 1/5	460	1.5	1075	10/370	6.50	5.60	1/2
20480	1/2 - 1/6	460	1.46	1075	10/440	5.50	5.70	1/2
20481	3/4 - 1/4	460	2.12	1075	15/440	5.50	6.48	1/2

One-On-One™ Replacement Motor for AO Smith ORM4688BF

MARS NO.	HP	ROT	RPM/SPDS	VOLTS	AMPS	CAP REQ.	ENCL.	BRG.	DIMENSIONS		
									A	B	C
20884	1/8, 1/6, 1/5, 1/4, 1/3	REV	825/1	460	1.0	7.5/370	TEAO	Ball	6.50	5.3	1/2

* CW Rotation-opposite shaft end

Super-Fit™ Multi-Horsepower Condenser 42 Frame Fan Motors

Ball Bearing

MARS 42 frame Super-Fit™ multi-horsepower condenser fan motors are ideal for truck stock. Two models cover 208-230V applications from 1/12 HP through 1/4 HP replacing many AOS, Westinghouse, Fasco, Emerson and GE motor designs.



Features:

- Super-Fit™ mounting holes for Trane 4.33, 4.42 and 4.62 bolt circle mounting. Includes self threading screws.
- All angle mount
- Reversible rotation
- Multi-HP
- Capacitor requirement noted on motor label
- 1/2 inch dia. flatted shaft
- Totally enclosed

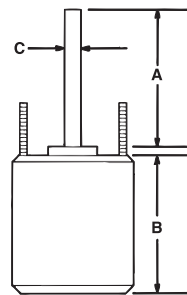

Specifications:

- Class "B" insulation
- 42 frame
- Single phase, 60 Hz
- Continuous air over
- Thermal overload protected
- Continuous duty
- 36 inch leads
- UL Recognized

Reversible Rotation – Single Speed

MARS NO.	HP	VOLTS	AMPS	RMP	CAP	ENCL.	BRG.	DIMENSIONS		
								A	B	C
10722	1/8, 1/10, 1/12	208-230	0.75	1075	5/370	TEAO	Ball	3.00	4.13	1/2
10723	1/4, 1/5, 1/6	208-230	1.5	1075	7.5/370	TEAO	Ball	3.00	4.72	1/2
10724	1/4, 1/5, 1/6	208-230	1.35	1625	5/370	TEAO	Ball	3.00	4.60	1/2

Direct Drive Blower Motors

Direct Drive Blower Motors

MARS direct drive furnace blower motors are three speed standard efficiency models. All models are electrically reversible and include 2-1/4 inch resilient rings for base mounting. These models have all angle sleeve bearings and have open air over enclosures.

Features:

- Sleeve bearing
- Rheem mounting holes
- 3 speeds
- 1/2 inch extended thru bolts
- 2-1/4 inch resilient rings
- For accessories see pages M-44 – M-46

Specifications:

- Class “B” insulation
- Single phase, 60 Hertz
- Thermal overload protected
- Fan duty, continuous, air over
- Open construction
- 36 inch leads
- UL Recognized

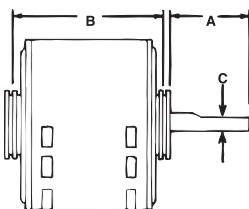

High Efficiency Direct Drive Blower Motors – MARS Energy Master

Ball Bearing

MARS High Efficiency direct drive blower motors save ENERGY. Designed for continuous air over applications, such as furnace blowers or central air handling units with single shaft requirements.

Features:

- Optimized high efficiency design
- 12-15% more efficient compared to standard motors
- Permanently lubricated ball bearings
- Rheem mounting holes
- Extended thru bolts, shaft end
- 3 Speeds
- Open Construction
- 2-1/4 resilient rings - plus 2-1/2 split rings included

Specifications:

- Class “B” insulation
- Single phase, 60 Hertz
- Fan duty, continuous air over
- Automatic thermal overload protection
- 36 inch leads
- UL Recognized

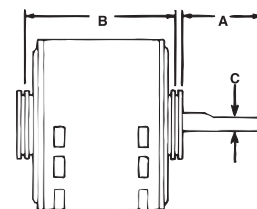

1075 RPM – Three Speed – Reversible Rotation

MARS NO.	HP	ROT	VOLTS	AMPS	CAP REQ.	ENCL.	BRG.	DIMENSIONS		
								A	B	C
10583	1/4	Rev	115	4.2	5/370	OAO	Slv	4.50	4.89	1/2
10584	1/4	Rev	208-230	1.8	5/370	OAO	Slv	4.50	4.89	1/2
10585	1/3	Rev	115	6.1	5/370	OAO	Slv	4.50	5.14	1/2
10586	1/3	Rev	208-230	2.7	5/370	OAO	Slv	4.50	5.14	1/2
10587	1/2	Rev	115	7.5	10/370	OAO	Slv	4.50	5.89	1/2
10588	1/2	Rev	208-230	3.2	7.5/370	OAO	Slv	4.50	5.64	1/2
10589	3/4	Rev	115	11.2	15/370	OAO	Slv	4.50	6.14	1/2
10590	3/4	Rev	208-230	4.5	10/370	OAO	Slv	4.50	6.14	1/2
10591	1	Rev	115	11.8	20/370	OAO	Slv	4.50	5.80	1/2
10592	1	Rev	208-230	5.6	15/370	OAO	Slv	4.50	5.80	1/2

1075 RPM – Reversible Rotation

MARS NO.	HP	VOLTS	AMPS	CAP REQ.	ENCL.	BRG.	DIMENSIONS		
							A	B	C
10573	1/4	115	2.9	7.5/370	OPAO	Ball	4.50	4.07	1/2
10574	1/4	208-230	1.3	5/370	OPAO	Ball	4.50	4.07	1/2
10575	1/3	115	3.9	10/370	OPAO	Ball	4.50	4.58	1/2
10576	1/3	208-230	1.6	7.5/370	OPAO	Ball	4.50	4.58	1/2
10577	1/2	115	5.2	15/370	OPAO	Ball	4.50	5.28	1/2
10578	1/2	208-230	2.5	10/370	OPAO	Ball	4.50	5.28	1/2
10579	3/4	115	8.0	20/370	OPAO	Ball	4.50	5.60	1/2
10580	3/4	208-230	3.5	15/370	OPAO	Ball	4.50	5.60	1/2

MARS 48 Frame Torsion Flex Mount Motors

MARS torsion flex mount motors are designed for direct drive furnace blower applications. The unique torsion flex mounting speeds installation while the special steel of the torsion flex bracket absorbs vibration for quieter operations. All models are electrically reversible, 3 speed motors.

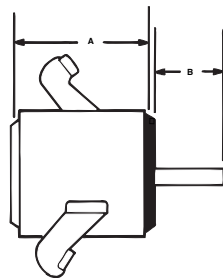

Features:

- Sleeve bearing
- Torsion flex mount
- 3 speeds
- 4-1/2 inch long, 1/2 inch diameter shaft
- Torsion mount sleeves and grommets included

Specifications:

- Class "B" insulation
- Single phase, 60 Hertz
- Thermal overload protected
- Fan duty, continuous, air over
- Open construction
- 36 inch leads
- UL Recognized

1075 RPM – Three Speed – Reversible Rotation

MARS NO.	HP	ROTATION	VOLTS	AMPS	CAP REQ.	ENCL.	BRG.	DIMENSIONS		
								A	B	C
10683	1/4	REV	115	4.2	5/370	OAO	SLV	4.50	4.89	1/2
10684	1/4	REV	208-230	1.8	5/370	OAO	SLV	4.50	4.89	1/2
10685	1/3	REV	115	6.1	5/370	OAO	SLV	4.50	5.14	1/2
10686	1/3	REV	208-230	2.7	5/370	OAO	SLV	4.50	5.14	1/2
10687	1/2	REV	115	7.5	10/370	OAO	SLV	4.50	5.89	1/2
10688	1/2	REV	208-230	3.2	7.5/370	OAO	SLV	4.50	5.64	1/2
10689	3/4	REV	115	11.2	15/370	OAO	SLV	4.50	6.14	1/2
10690	3/4	REV	208-230	4.5	10/370	OAO	SLV	4.50	6.14	1/2

Multi-Horsepower Direct Drive Blower Motors

MARS multi-horsepower direct drive blower motors are ideal for truck stock. Four models cover both 115 volt and 208-230 volt applications from 1/6 through 3/4 HP. All MARS multi-horsepower motors feature Rheem shell mounting holes.

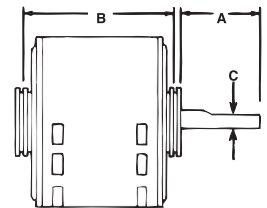

Features:

- Rheem mounting holes
- 2-1/4 inch resilient rings

Specifications:

- Class "B" insulation
- Single phase, 60 Hz
- Thermal overload protected
- 36 & 41 inch leads
- UL Recognized

Four Speed

MARS NO.	HP	ROT	VOLTS	RPM	ENCL.	BRG.	DIMENSIONS			LEAD LENGTHS
							A	B	C	
10463	1/6 - 1/2	Rev	115	1075	OAO	Slv	5.50	4.73	1/2	41"
10464	1/6 - 1/2	Rev	208-230	1075	OAO	Slv	5.50	4.73	1/2	41"
10466	1/5 - 3/4	Rev	115	1075	OAO	Ball	5.80	5.73	1/2	41"
10467	1/5 - 3/4	Rev	208-230	1075	OAO	Ball	5.60	5.23	1/2	41"
10479	1/8 - 1/3	Rev	208-230	825	OAO	Slv	4.50	5.30	1/2	36"

MARS 460V Direct Drive Blower Motors

Ball Bearing

MARS direct drive blower motors are installed in residential and commercial furnaces, air conditioners, exhaust fans, and other air handling equipment.



Features:

- All angle
- 2 speeds
- Extended studs
- 2-1/4 inch resilient rings

Specifications:

- Class "B" insulation
- Single phase, 60 Hz
- Thermal overload protected
- 36 inch leads
- UL Recognized

Reversible Rotation

MARS NO.	HP	VOLTS	AMPS	CAP REQ.	ENCL.	BRG.	DIMENSIONS		
							A	B	C
20538	1/2	460	1.8	10/370	OAO	Ball	6.50	5.25	1/2

Multi-Horsepower – Reversible Rotation

MARS NO.	HP	VOLTS	AMPS	CAP REQ.	ENCL.	BRG.	DIMENSIONS		
							A	B	C
20580	1/3 - 1/4	460	0.95	7.5/370	OAO	Ball	6.50	4.50	1/2
20581	3/4 - 1/2	460	2.1	15/370	OAO	Ball	4.50	5.80	1/2

See diagram above for dimensions

Fan & Blower Motors

Belted Fan & Blower Motors

Ball Bearing

MARS belted blower motors are designed to meet manufacturer's requirements for belted fan or blowers.

Features:

- Resilient base mounted
- Single speed
- Slotted holes in base match 48 or 56 frame bolt patterns
- 1/2 inch shaft diameter

Specifications:

- Class "B" insulation
- Single phase, 60 Hz
- Thermal overload protected
- Open construction
- Continuous duty
- UL Recognized

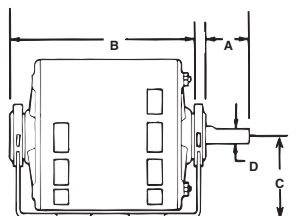
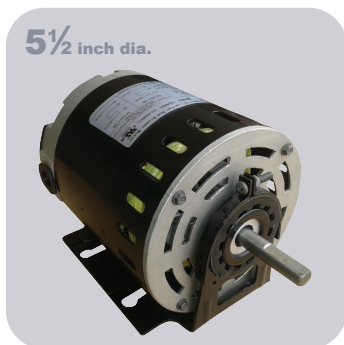

1725 RPM – Single Speed – Reversible Rotation

MARS NO.	HP	VOLTS	FLA	SF	DIMENSIONS				NEMA FRAME
					A	B	C	D	
10401	1/4	115	4.3	1.35	1.85	6.25	3.00	1/2	48/56
10406	1/3	115	5.8	1.35	1.85	6.25	3.00	1/2	48/56
10408	1/2	115	7.7	1.25	1.85	6.88	3.00	1/2	48/56

Tech Tip

When replacing a blower or fan motor, inspect the blower wheel or fan and replace or clean as necessary to optimize performance.

Belted Fan & Blower Motors, Split Phase

Ball Bearing

MARS belted blower motors are designed to meet manufacturer's requirements for belted fan or blowers.

Features:

- Single speed, split phase
- 48/56 frame mounting holes
- Heavy gauge steel construction frame and base
- 1/2" x 1-7/8" Shaft with 1-5/8" Flat
- Extended thru bolts

Specifications:

- Class "B" insulation
- Single phase, 60 Hz
- Continuous duty
- Automatic thermal overload protection, as noted
- cULus

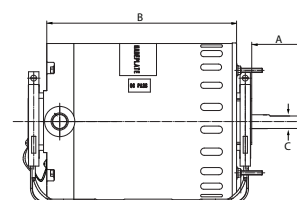
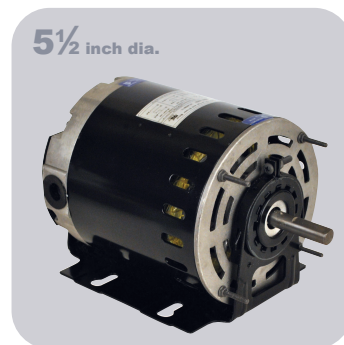

Cross Reference:

MARS No.	AO Smith/ Century	Baldor	Emerson/ US Motors	Genteq	Magnetek	Marathon
10302	919L	-	DB14B2N4Z	-	919	B302
10303	920L, GF2024	RSP1441A	8000, 3618	4701, 4730	808	B303, B206
10304	921L, RB2034L	-	D13B2N4Z9	-	921	B304
10305	922L, RB2034	-	8100, PD6004	-	922	B305, B207
10306	-	-	D12C2J49	-	-	B306
10307	GF2054	RSP3451A	8200, PD6006	4708, 4733	-	B307

1725 RPM - Reversible - Dripproof

MARS NO.	HP	VOLTS	AMPS	S.F	ENCL.	BRG.	NEMA FRAME	DIMENSIONS		
								A	B	C
10303*	1/4	115	4.3	1.35	DP	Ball	48Y	1.85	6.25	1/2
10305*	1/3	115	5.8	1.35	DP	Ball	48Y	1.85	6.25	1/2
10307*	1/2	115	7.7	1.25	DP	Ball	48Y	1.85	6.88	1/2
10302	1/4	115	4.3	1.35	DP	Ball	48Y	1.85	6.25	1/2
10304	1/3	115	5.8	1.35	DP	Ball	48Y	1.85	6.25	1/2
10306	1/2	115	5.8	1.35	DP	Ball	48Y	1.85	6.88	1/2

* Automatic Thermal Overload Protection

Fan & Blower Motors, Capacitor Start

Ball Bearing

MARS fan & blower motors are designed for applications like commercial fans and blowers, direct and belt drive air handlers and exhaust fans.

Features:

- Single speed, capacitor start
- 48/56 frame mounting holes
- Heavy gauge steel construction frame and base
- 5/8" Shaft dia. with keyway
- Extended thru bolts

Specifications:

- Class "B" insulation
- Single phase, 60 Hz
- Continuous duty
- Automatic thermal overload Protection, as noted
- cULus

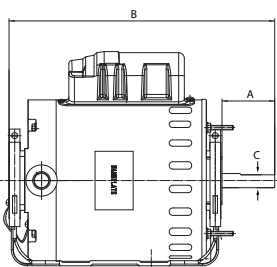

Cross Reference:

MARS No.	AO Smith/ Century	Baldor	Emerson/ US Motors	Fasco	Leeson	Magnetek	Marathon
10313	C196L	RL1203A	D12CPA2P49	-	100109.00	C196	B313
10315	RBF1034A	-	180	-	-	-	B315
10317	BK1054, C412V1	-	D12CPA2PH9	D6084	100011.00	-	B317
10319	C426V1, RB1074A	RL1307A	1893	-	100012.00	-	B319
10321	C523V1	RL1310A	D1CPA2PH9	D6088	110007.00	-	4688

1725 RPM - Reversible - Dripproof

MARS NO.	HP	VOLTS	AMPS	S.F	ENCL.	BRG.	NEMA FRAME	DIMENSIONS		
								A	B	C
10313*	1/4	115/208-230	5.0/2.4-2.5	1.35	DP	Ball	48YZ	1.85	10.30	1/2
10315*	1/3	115/208-230	5.4/2.6-2.7	1.35	DP	Ball	48Z	1.93	10.22	1/2
10317*	1/2	115/208-230	8.0/4.1-4.0	1.25	DP	Ball	56	1.93	10.41	5/8
10319*	3/4	115/208-230	10.0/5.2-5.0	1.25	DP	Ball	56	1.93	11.00	5/8
10321*	1	115/208-230	14.4/7.2-7.2	1.00	DP	Ball	56	1.95	11.26	5/8

* Automatic Thermal Overload Protection

Commercial Condenser Fan Motors, Rigid Base, 3 Phase

Ball Bearing

MARS Commercial condenser fan motors may be installed outdoors. These motors need to be mounted within the airflow of the fan for proper cooling. 56Z or 56HZ rigid base is easy to remove and provides mounting flexibility. Use on Trane, Carrier, Climatrol and York units, 5 tons and larger.

Features:

- 70°C ambient except as noted
- VFD Compatible
- Water slinger on shaft
- Rigid Base - Horizontal or Vertical mounting
- Enclosed shaft end bracket, vented frame
- Flat and keyway on shaft

Specifications:

- Class "H1" insulation
- Three Phase, 60/50 Hz
- Continuous duty, air over
- Automatic thermal overload protected
- cULus

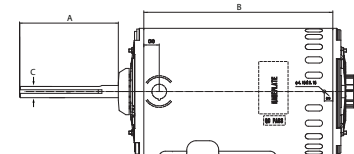
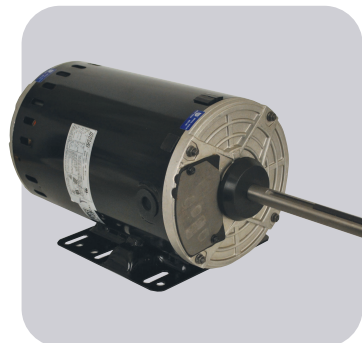

Cross Reference:

MARS No.	AO Smith/ Century	Baldor	Emerson/ US Motors	Leeson	Marathon
10513	H1050A	-	1820H, 1820V	-	X513
10523	H1051A	CFM3166A	1821H, 1821V	111148	X523
10531	H1054A	-	1831H, 1831V, 1100	-	X531

MARS NO.	HP	VOLTS	AMPS	S.F	ENCL.	BRG.	NEMA FRAME	DIMENSIONS		
								A	B	C

1140 RPM - Reversible - Three Phase

10533*	1/2	208-230/460	2.1-2.0/1.0	1.0	OPAO	Ball	56Z	5.50	7.14	5/8
10513	1	208-230/460	4.1-4.5/2.3	1.0	OPAO	Ball	56HZ	5.00	7.66	5/8
10523	1-1/2	208-230/460	5.7-5.8/2.9	1.0	OPAO	Ball	56HZ	5.00	8.45	5/8

850 RPM - Reversible - Three Phase

10531	1-1/2	208-230/460	6.5-6.7/3.4	1.0	OPAO	Ball	56HZ	5.00	9.23	5/8
-------	-------	-------------	-------------	-----	------	------	------	------	------	-----

* 60 Deg C

Commercial Condenser Fan Motors / Heating Motors

Commercial Condenser Fan Motors, Belly Band, 3 Phase

Ball Bearing

MARS Commercial condenser fan motors may be installed outdoors. These motors need to be mounted within the airflow of the fan for proper cooling. Use on Trane, Carrier, Climatrol and York units, 5 tons and larger.

Features:

- 70°C ambient
- VFD Compatible, except 575V
- Water slinger on shaft
- Four locating screws 90° apart, 3-3/8" from outer edge of shaft slinger
- Enclosed shaft end bracket, vented frame
- Flat and keyway on shaft
- Belly Band and Resilient Ring Mounting

Specifications:

- Class "H1" insulation
- Three Phase, 60/50 Hz, 575V - 60 Hz only
- Continuous duty, air over
- Automatic thermal overload protected
- cULus

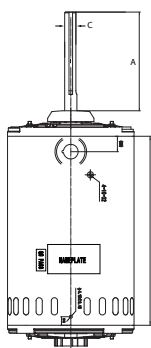

Unit Heater Motors, PSC

Ball Bearing

MARS replacement unit heater motors need to be mounted within the airstream for proper cooling.

Features:

- Totally enclosed, air over
- Horizontal or vertical mount
- 1" extended thru-bolts
- Reversing plug
- BX connector mounted in frame

Specifications:

- Class "B" insulation
- Single phase, 60 Hz
- Continuous duty
- Automatic reset thermal overload
- 37 inch leads
- cULus

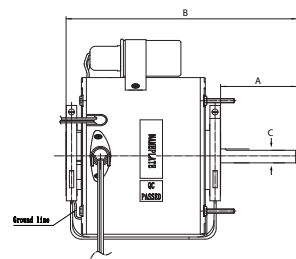
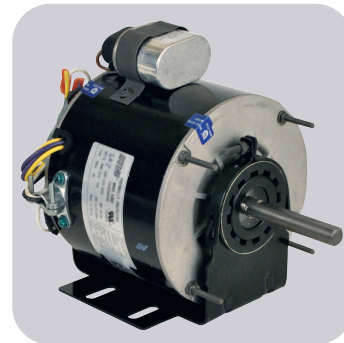

Cross Reference:

MARS No.	AO Smith/ Century	Emerson/ US Motors	Marathon
30301	UH1016, US1016	1386	X302
30303	566A, UH1026	1384	X303
30305	UH1036	1388	X304

Cross Reference:

MARS No.	AO Smith/ Century	Baldor	Emerson/ US Motors	Fasco	Magnetek	Marathon
10502	FC3106F	CFM3156A	1818H	-	H667	X502
10503	H1051A	CFM3166A	1819H	D6610	H767	X503
10507	H1053A	-	1828H, 1828V	-	H686	X507
10509	H698	-	8987V	-	-	X509
10530	H1054A, H1053A	-	1832H, 1832V	-	-	X530

1075 RPM - Reversible

MARS NO.	HP	VOLTS	AMPS	CAPACITOR INCLUDED	ENCL. BRG.	NEMA FRAME	DIMENSIONS			
							A	B	C	
30301	1/6	115	3.0	5/370	TEAO	Ball	48Y	2.75	8.25	1/2
30303	1/4	115	4.1	7.5/370	TEAO	Ball	48Y	2.75	8.25	1/2
30305	1/3	115	6.5	7.5/370	TEAO	Ball	48Y	2.75	9.70	1/2

MARS NO.	HP	VOLTS	AMPS	S.F	ENCL.	BRG.	NEMA FRAME	DIMENSIONS		
								A	B	C

1140 RPM - Reversible - Three Phase

10502	1	208-230/460	4.18-4.38/2.19	1.0	OPAO	Ball	56Y	5.00	7.66	5/8
10503	1-1/2	208-230/460	5.3-5.09/2.55	1.0	OPAO	Ball	56Y	5.00	8.84	5/8
10509	2	208-230/460	7.3-7.0/3.7	1.0	OPAO	Ball	56Y	5.00	9.62	5/8

850 RPM - Reversible - Three Phase

10507	1	208-230/460	5.1-5.1/2.53	1.0	OPAO	Ball	56Y	5.00	8.84	5/8
10530	1-1/2	208-230/460	7.05-6.7/3.57	1.0	OPAO	Ball	56Y	5.00	9.62	5/8

MARS Oil Burner Motors

Ball Bearing

MARS Oil Burner Motors are replacement motors for residential and commercial oil burners, hot water pressure/steam cleaners and other applications where 48M or 48N flange mounting is required.

Features:

- All angle
- Split Phase and PSC
- Semi or totally enclosed
- Two bolt direct mounting for 48M and 48N

Specifications:

- Class "B" insulation
- Single phase, 60 Hertz
- Continuous duty
- Manual reset overload protection
- Auto reset protection for PSC
- cULus

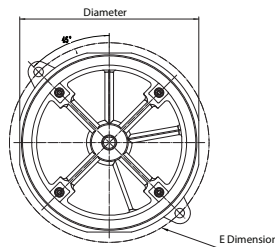
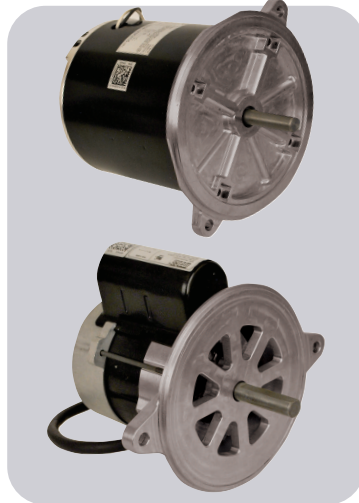

Cross Reference:

MARS No.	AO Smith/ Century	Beckett	Emerson/ US Motors	Marathon
30004	EL2022	-	2302	O004
30011	OI2052D	-	3267	O011
30100	EL2002	-	3083	O100
30600	EL2005	-	3196	O600
30601	XEL2014	-	3252	O601
30701	-	21805U	3274	O701

MARS NO.	DIA.	HP	RPM/ SPD	VOLTS	AMPS	ROT.	FRAME	ENCL.	S.F.	SHAFT LGTH	SHAFT DIA.	E DIM.
----------	------	----	----------	-------	------	------	-------	-------	------	------------	------------	--------

Split Phase

30100	5-1/2	1/7	3450/1	115	2.4	Rev	48M	Semi Enclosed	1.0	1-3/4	1/2	6-3/4
30600	6-1/2	1/8	1725/1	115	2.7	Rev	48N	TENV	1.0	1-3/4	1/2	7-1/4
30601	6-1/2	1/6	1725/1	115	2.8	Rev	48N	TENV	1.0	1-3/4	1/2	6-1/2
30004	6-1/2	1/4	3450/1	115	3.8	Rev	48N	Semi Enclosed	1.0	1-13/16	1/2	7-1/4

Oil Burner, PSC

30701	5-1/2	1/7	3450/1	115	1.5	CCW SE	-	Semi Enclosed	-	1-3/4	1/2	5-1/4
30011	6-1/2	1/2	3450/1	115/208-230	8.2/4.1	Rev	48N	Semi Enclosed	1.0	1-3/4	1/2	7-1/4

51 Frame Unit Bearing Cast Iron Motors

MARS 51 frame motors are used on refrigerators, freezers, food & beverage coolers, vending machines, display cases, and many other fan duty applications.

Features:

- Cast iron construction
- Packed with vibration dampener, speed nut & screws
- Shaded pole, single phase
- Fan duty, continuous, air over
- Impedance protected
- For accessories see pages M-44 – M-46
- Class "A" insulation
- 60/50 Hertz

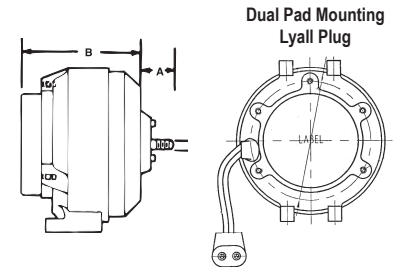

MARS NO.	WATTS	ROT OSE	VOLTS	AMPS	LEAD LENGTH	DIMENSIONS		
						A	B	C

1550 RPM—1/4-20 Threaded Shaft - Dual Pad Mounting - Lyall Plug

05211 ⁽¹⁾	4	CW	115	0.33	24"	0.66	2.64	1/4
05212 ⁽¹⁾	4	CCW	115	0.33	24"	0.66	2.64	1/4
05221 ⁽¹⁾	4	CW	230	0.19	24"	0.66	2.64	1/4
05222 ⁽¹⁾	4	CCW	230	0.19	24"	0.66	2.64	1/4
05311	6	CW	115	0.46	24"	0.66	3.14	1/4
05312	6	CCW	115	0.46	24"	0.66	3.14	1/4
05411	9	CW	115	0.62	24"	0.66	3.14	1/4
05412	9	CCW	115	0.62	24"	0.66	3.14	1/4
05421	9	CW	230	0.33	24"	0.66	3.14	1/4
05422	9	CCW	230	0.33	24"	0.66	3.14	1/4
05811 ⁽²⁾	16	CW	115	0.95	24"	0.66	3.34	1/4
05812 ⁽²⁾	16	CCW	115	0.95	24"	0.66	3.34	1/4
05821 ⁽²⁾	16	CW	230	0.48	24"	0.66	3.34	1/4
05822 ⁽²⁾	16	CCW	230	0.48	24"	0.66	3.34	1/4

1500 RPM—1/4-20 Threaded Shaft

05721 ⁽²⁾	35	CW	230	0.70	22"	0.50	3.50	1/4
----------------------	----	----	-----	------	-----	------	------	-----

1500 RPM—Smooth Shaft

05511 ⁽²⁾	50	CW	115	1.7	22"	1.50	4.50	3/8
05521 ⁽²⁾	50	CW	230	0.85	22"	1.50	4.50	3/8

(1) Class A Insulation

(2) Automatic Reset Overload Protection

Unit Bearing Motors / C-Frame Motors

51 Frame Unit Bearing Aluminum Motors

MARS aluminum 51 frame motors are economical replacements for cast iron motors. They feature an improved oiling system and class B insulation for longer life.

Features:

- Aluminum construction
- Unit bearing design
- Packed with vibration dampener, speed nut & screws
- Shaded pole, single phase
- Fan duty, continuous, air over
- Impedance protected
- For accessories see pages M-44 – M-46
- Class "A" insulation
- 60/50 Hertz

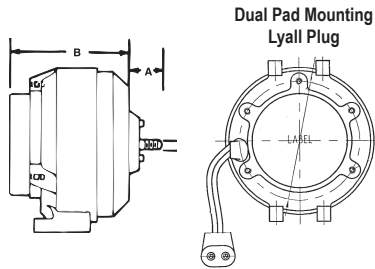

MARS NO.	WATTS	ROT OSE	VOLTS	AMPS	LEAD LENGTH	DIMENSIONS		
						A	B	C
1550 RPM—1/4-20 Threaded Shaft - Dual Pad Mounting - Lyall Plug								
05213 ⁽¹⁾	4	CW	115	0.33	24"	0.66	2.64	1/4
05223 ⁽¹⁾	4	CW	230	0.19	24"	0.66	2.64	1/4
05313	6	CW	115	0.46	24"	0.66	3.14	1/4
05413	9	CW	115	0.62	24"	0.66	3.14	1/4
05414	9	CCW	115	0.62	24"	0.66	3.14	1/4
05423	9	CW	230	0.33	24"	0.66	3.14	1/4
05813 ⁽¹⁾⁽²⁾	16	CW	115	0.95	24"	0.66	3.34	1/4
05814 ⁽¹⁾⁽²⁾	16	CCW	115	0.95	24"	0.66	3.34	1/4
05823 ⁽¹⁾⁽²⁾	16	CW	230	0.48	24"	0.66	3.34	1/4

(1) Class A Insulation
 (2) Automatic Reset Overload Protection

Super-Fit™ 3000 RPM Replacement Motor*

The MARS 90999 Super-Fit™ replacement fan motor is designed to replace virtually any refrigerator evaporator fan motor.

The MARS 90999 motor incorporates a unique new system which duplicates any OEM mounting quickly and easily. The rotor is reversible in the field for either clockwise or counterclockwise rotation.

In addition the MARS 90999 motor has the power to perform in even the largest refrigerators.

The MARS 90999 Super-Fit™ motor comes complete with mounting accessories and hardware.

*U.S. Patent

Features:

- Reversible rotation
- Duplicates any OEM motor
- Break-off shaft
- Easy-to-use, fewer parts to assemble than competitive motors
- Stock one motor - save on inventory
- Complete with accessories and instructions

Specifications:

- Electrical rating: 90999, 115V, 50/60 Hertz
- Overload protection: impedance protected
- Speed: 3000 RPM
- Shaft: 1/8 inch diameter with adaptors for 3/16 inch and hubless fans

MARS NO.	DESCRIPTION	VOLTS
90999	"Super-Fit" motor with accessories	115V, 50/60 Hz

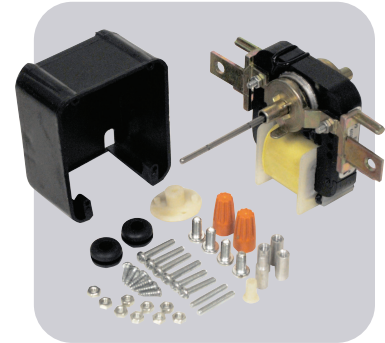

Replaces these popular motors... and hundreds more!

WHIRLPOOL/COLDSLOT

FRIGIDAIRE

GIBSON

WESTINGHOUSE

PHILCO

Super-Fit™ 3000 RPM Commercial Replacement Motor*

MARS 90970 Super-Fit™ commercial evaporator fan motor is the most versatile, easy-to-use, heavy-duty replacement evaporator fan motor available.

MARS 90970 is the first motor of this type with a dual voltage coil so you can stock one motor for both 115 volt and 230 volt applications. The unique system of slide locator screws lets you match OEM mountings quickly and easily.

The reversible 90970 features rugged, die cast bearing housings with self-aligning bearings and generous oil reservoir. The break-off shaft has adaptors to fit 1/8, 3/16, 1/4, 5/16 inch bores and hubless fan blades.

Each kit includes: Motor, 5.5" white plastic blade, accessory package.

*U.S. Patent



MARS 90970 Replaces:

ACME MIAMI	GEM	UNI-LINE ROBERT SHAW
750	EM675 EM680	14011
7502	EM675 EM683	14019
780		

Features:

- Dual voltage coil, 110-120/208-240 VAC
- 50/60 Hertz
- Mechanically reversible

Specifications:

- Electrical: 110-120/208-240 VAC; 50/60 Hertz
- Protection: thermal overload protected
- HP: 1/50
- RPM: 3000

3000 RPM – Mechanically Reversible

MARS NO.	HP	AMPS	STACK HT. IN.	SHAFT	VOLTS
90970	1/50	1.33	.75	2.174 X .1875	110-120/208-240

Super-Fit™ 3000 RPM Replacement Motor Kit With Fan Blades

The MARS 90971 Super-Fit™ replacement motor kit with fan blades is designed to provide all the material necessary to replace virtually any existing application that requires a 3/8", 1/2", or 5/8" stack motor.

The motor features a specially designed recirculating oil system for long life.

Each kit includes: MARS Super-Fit™ Motor, hardware plus a 4" diameter fan blade and a 5.5" diameter fan blade.

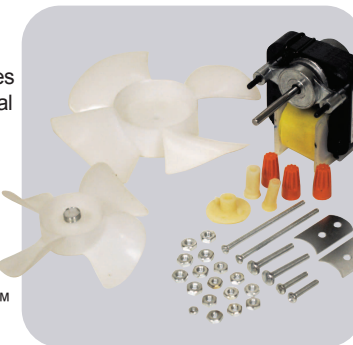

Features:

- Sleeve bearings
- All angle mount
- UL and CSA recognized
- Impedance protection
- Mechanically reversible
- Recirculating oil system

Specifications:

- Class "A" insulation
- 3000 RPM
- 60 Hz

3000 RPM – Mechanically Reversible

MARS NO.	HP	VOLTS	AMPS	SHAFT	STACK
90971	1/130	120	0.41	1.42" x 3/16"	5/8"

MARS 3.3" Commercial Refrigeration Multi-Horsepower Motors

These motors replace hundreds of OEM shaded pole evaporator fan motors found in Bohn, Nutone, Chandler, Larkin, Kramer, Climate Control, McQuay, Heatcraft and reduce truck stock costs.

These PSC type motors deliver more power and lower amp draw compared to shaded pole.

Features:

- Sleeve bearing, single speed
- Mounting - extended thru-bolt with nuts
- Low temp lubricant
- Capacitor included
- Open ventilation

Specifications:

- Class "B" insulation
- 60 Hz
- Thermal overload protected

Replaces 12 Motor Ratings:

- 1/12HP CW or CCW 115V or 230V
- 1/15HP CW or CCW 115V or 230V
- 1/20HP CW or CCW 115V or 230V

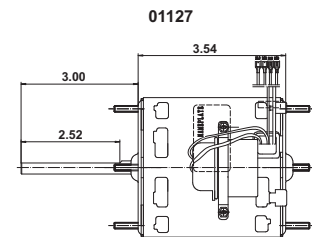
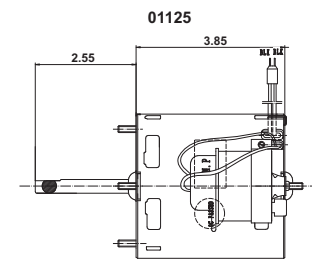

1550 RPM

MARS NO.	HP	VOLTS	ROT	AMPS	CAP INCLUDED	SHAFT LENGTH AND DIAMETER
01125	1/12, 1/15, 1/18	208-230	CW LE	0.56/0.50	4 MFD 370V	2.55 x 5/16
01127	1/12, 1/15, 1/20	115/230	REV	1.1/0.60	7.5 MFD 370V	3.00 x 5/16

Cross Reference:

MARS NO.	ACME MIAMI	GEM	UNI-LINE ROBERT SHAW	SUPCO
90971	600 700 710 AM-4670	EM670	33-670 (14001)	SM-670

Refrigeration Fan Motors / Draft Inducer Blowers

MARS Super-Fit™ 3.3" Commercial Refrigeration Evaporator Fan and Blower Motors

Application:

Can be used to replace virtually all popular 3.3" dia. commercial refrigeration evaporator fan motors.

Features:

- Adaptable to front or rear mount
- All angle operation
- Specially selected low temp. oil
- Full flatted black oxide shafts
- U.L. and C.S.A. recognized thermal protection

Specifications:

- Single phase, 60 Hertz
- Thermal overload protected
- 12 inch leads

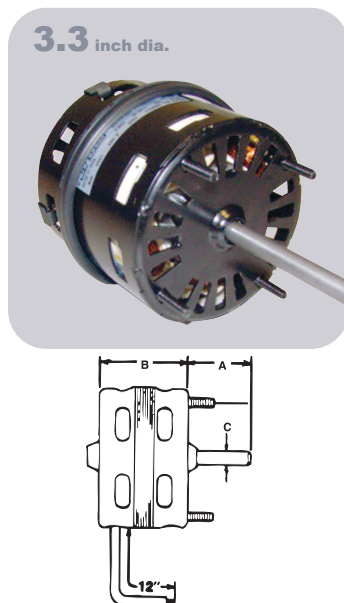

1550 RPM

MARS NO.	HP	VOLTS	AMPS	ROT OLE	DIMENSIONS			MOUNTING STUD LOCATION
					A	B	C	
09917	1/20	115	1.7	CW	2.50	2.96	5/16	SE
09927	1/20	208/230	0.96	CW	2.50	2.96	5/16	SE

MARS One-On-One™ 3.3" Commercial Refrigeration Evaporator Fan and Blower Motors

These motors feature original OEM-type plugs, wiring harness and conduit box (where appropriate).

Features:

- Sleeve bearing
- Original OEM-type mounting
- Original OEM-type wiring
- Specially selected low temp oil
- Full flatted black oxide shafts

Specifications:

- Single phase
- Thermal overload protected
- 12-1/2 inch leads



Bohn Applications/with Lyall Plug

MARS NO.	HP	RPM	VOLTS	AMPS	ROT OLE	DIMENSIONS			MOUNTING STUD LOCATION
						A	B	C	
09930	1/20	1550	115	1.7	CW	3	3	5/16	LE and SE
09931	1/15	1550	230	1.1	CW	3	3.5	5/16	SE

1550 RPM – Larkin Applications/with Lyall Plug

MARS NO.	HP	VOLTS	AMPS	ROT OLE	DIMENSIONS			MOUNTING STUD LOCATION
					A	B	C	
09932	1/20	115	1.7	CCW	2.25	2.75	5/16	LE
09933	1/20	208/230	1.0	CCW	2.25	3	5/16	LE

1550 RPM – McQuay Applications

MARS NO.	HP	VOLTS	AMPS	ROT OLE	DIMENSIONS			MOUNTING STUD LOCATION
					A	B	C	
09934	1/15	115/230	2.1/1.1	CW	2.5	3.5	5/16	SE

See diagram above for dimensions

Draft Inducer Blowers

Ball Bearing

MARS draft inducer blower assemblies are designed and manufactured to serve as drop-in, exact replacements.

Specifications:

- C-Frame
- Single Speed
- 60 Hz
- Thermal protected, air over
- Single phase

Draft Inducer Blowers

MARS NO.	OEM	OEM NO.	APPL.	HP	VOLTS	AMPS	RPM	CAP INCL.
10566	Carrier	HC27Q118	80+ Furnace	1/4	115	0.38	3030	5MFD/370
10704	Carrier	HC21ZE117	80+ Furnace	1/22	115	1.9	-	-
10709	Carrier	HC24HE230	80+ Furnace	1/40	208/230	1.0	-	-
10556	Nordyne	622567	80+ Furnace	1/33	115	0.43	3000	4MFD/250V
10558	Nordyne	622302	90+ Furnace	1/31	115	0.46	3300	6MFD/250V
10550	Goodman	0131G00007	80+ Furnace	1/50	230	0.24	3000	2MFD/370V
10551	Goodman	0131G00009	80+ Furnace	1/32	230	0.24	3000	2MFD/370V
10552	Goodman	0131M00121	80+ Furnace	1/50	230	0.22	3000	2MFD/370V
10553	Goodman	0131M00002P	80+ Furnace	1/50	115	0.40	3000	6MFD/250V
10555	Goodman	0271F00126	90+ Furnace	1/32	115	0.46	3150/2950	6MFD/250V
10563	Trane	D965130P01	80+ Furnace	1/39	230	0.22	2800/1500	2MFD/370V
10564	Trane	D965129P01	80+ Furnace	1/39	230	0.22	2800/1500	2MFD/370V
10565	Trane	D965128P01	80+ Furnace	1/34	230	0.24	3000	2MFD/370V

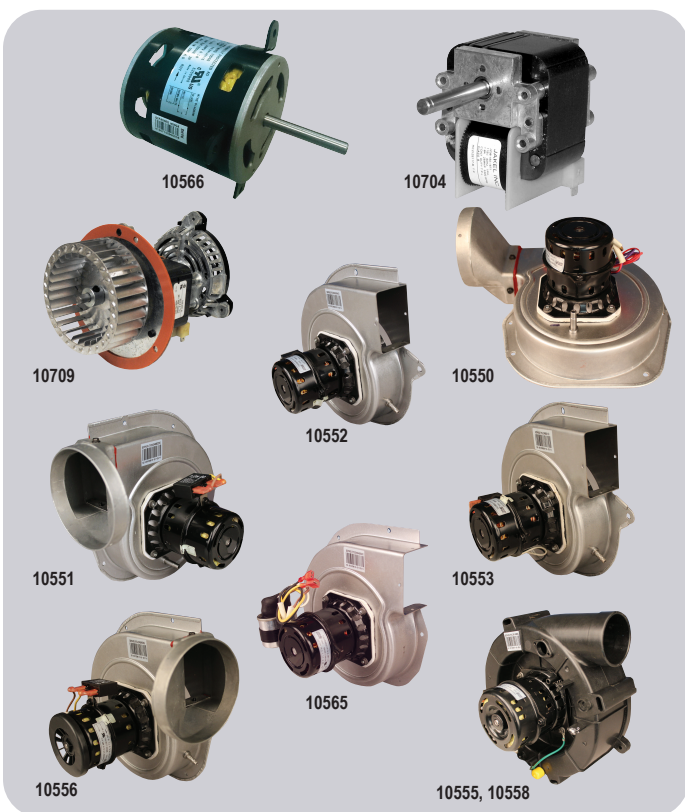

One-On-One™ Direct Replacement Motors

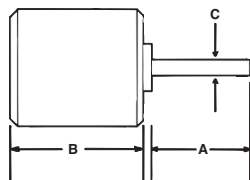

Replaces: Carrier HC33GE233

MARS USA, 5-1/2 inch diam., totally enclosed, ball bearing, capacitor required, 5 MFD @ 370V (MARS No. 12005, 12905, 14005), CW OSE

MARS NO.	HP	VOLTS	RPM/SPEEDS	ROT OSE	AMPS	DIMENSIONS		
						A	B	C
10234	1/10	208/230	1100/1	CW	0.77	1.8	3.8	1/2

Replaces: Goodman 0131M00019P

MARS USA, 5-1/2 inch diam., totally enclosed, ball bearing, capacitor required, 5 MFD @ 370V (MARS No. 12005, 12905, 14005), CCW OSE

MARS NO.	HP	VOLTS	RPM/SPEEDS	ROT OSE	AMPS	DIMENSIONS		
						A	B	C
10230	1/4	208/230	1100/1	CCW	1.26	3	4.1	1/2

Replaces: Goodman 0131M00060

MARS USA, 5-1/2 inch diam., totally enclosed, ball bearing, capacitor required, 5 MFD @ 370V (MARS No. 12005, 12905, 14005), CCW OSE

MARS NO.	HP	VOLTS	RPM/SPEEDS	ROT OSE	AMPS	DIMENSIONS		
						A	B	C
10232	1/6	208/230	810/1	CCW	1.1	3	4.1	1/2

Replaces: Goodman G3911

MARS USA, 5 1/2 inch diam. Totally enclosed, ball bearing, capacitor required, 5 MFD @ 370V (MARS No. 12005, 12905, 14005), CCW OSE

MARS NO.	HP	VOLTS	RPM/SPEEDS	ROT OSE	AMPS	DIMENSIONS		
						A	B	C
03242	1/6	208/230	1075/1	CCW	1.0	1	2.75	1/2

Replaces: Goodman 0131M00294

MARS USA, 5-1/2 inch diam., totally enclosed, ball bearing, capacitor required, 5 MFD @ 370V (MARS No. 12005, 12905, 14005), CCW OSE

MARS NO.	HP	VOLTS	RPM/SPEEDS	ROT OSE	AMPS	DIMENSIONS		
						A	B	C
10233	1/8	208/230	1050/1	CCW	0.70	2.5	4.1	1/2

Replaces: Goodman 0131F00022

MARS USA, 5-1/2 inch diam., totally enclosed, ball bearing, capacitor required, 20 MFD @ 370V (MARS No. 12014, 12914, 14014), CW OSE

MARS NO.	HP	VOLTS	RPM/SPEEDS	ROT OSE	AMPS	DIMENSIONS		
						A	B	C
10594	1/2	115	1130/4	CW	8.1	4	5.1	1/2

Replaces: For use with Coleman and Evcon Equipment

5-1/2 inch diam., totally enclosed, ball bearing, capacitor required, 5 MFD @ 440V (MARS No. 12029, 12929, 14029), CCW OSE

MARS NO.	HP	VOLTS/PHASE	RPM/SPEEDS	ROT OSE	AMPS	DIMENSIONS		
						A	B	C
10570	1/3	575/1	850/1	CCW	0.66	2.5	6.6	1/2

Replaces: For use with Coleman and Evcon Equipment

5-1/2 inch diam., totally enclosed, ball bearing, capacitor required, 10 MFD @ 440V (MARS No. 12032, 12932, 14032), CCW OSE

MARS NO.	HP	VOLTS/PHASE	RPM/SPEEDS	ROT OSE	AMPS	DIMENSIONS		
						A	B	C
10571	3/4	575/1	1100/1	CW-LE	1.35	3.5	5.7	1/2

OEM Direct Replacement Motors For Copeland

Specifications:

- Class "B" insulation
- 50/60 Hz
- Single phase
- Single speed
- Thermal overload protected
- Continuous air over

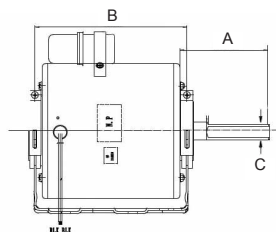

MARS NO.	HP	VOLTS	ROT OSE	AMPS	RPM	CAP INCLUDED	ENCL.	DIMENSIONS		
								A	B	C
10227	1/3	230	CW	2.2	1625	4MFD/370V	TEAO	1.75	5.87	1/2
10228	1/6	208-230	CW	1.1	1550	3MFD/370V	OAO	3.07	3.69	1/2
10229	1/4	208-230	CW	1.5	1625	5MFD/370V	OAO	3.07	4.32	1/2
10264	1/4	230	CW	2.1	1550	5MFD/370V	ODP	3.00	4.20	1/2
10265	1/6	208-230	Rev	1.1	1550	3MFD/370V	OAO	3.00	3.73	1/2

Tech Tip

Always replace the capacitor when replacing a PSC motor.

MARS No.	Description	Century / AO Smith	US Motors/ Emerson	Fasco	GE/ Gented	Marathon	Packard	Nordyne/ Partners Choice	Rheem/Ruud Protech	Carrier/ Totaline RCD	Wagner	York Source 1	ROTHOM
Condenser Fan													
10725	1/8 HP, 208-230 V, 1075 RPM, B/B	-	-	D919	-	-	-	-	-	-	-	-	-
10727	1/6 HP, 208-230 V, 1075 RPM, B/B	FSE1016	1859	D917	3727	X411	43727	01-0160	W51-16CJA1-01	P257-8727	WG840727	S1-FHM3727	-
10728	1/4 HP, 208-230 V, 1075 RPM, B/B	FSE1026	1860	D909	3728	X412	43728	01-0161	W51-14CJA1-01	P257-8728	WG840728	S1-FHM3728	-
10729	1/3 HP, 208-230 V, 1075 RPM, B/B	FSE1036	1861	D908	3729	X413	43729	01-0162	W51-13CJA1-01	P257-8729	WG840729	S1-FHM3729	-
10730	1/2 HP, 208-230 V, 1075 RPM, B/B	FSE1056	1862	D907	3730	X414	43730	01-0163	W51-12CJA1-01	P257-8730	WG840730	S1-FHM3730	-
10731	3/4 HP, 208-230 V, 1075 RPM, B/B	FSE1076	1868	D933	3731	-	43731	01-0164	51-42534-19	P257-8731	WG840731	S1-FHM3731	-
10403	1/6 HP, 208-230 V, 825 RPM, B/B	FSE1018SF	1873	D798	3403	X465	60825	0165	51-23055-12	-	-	-	-
10404	1/4 HP, 208-230 V, 825 RPM, B/B	FSE1028SF	1874	D934	3404	-	40825	0166	51-23054-13	-	WG840204	S1-FHM3204	R22445
10405	1/3 HP, 208-230 V, 825 RPM, B/B	FSE1038SF	1875	D796	3405	X451	30825	0167	-	P257-8026	WG840205	S1-FHM3205	R22345
10746	1/2 HP, 208-230 V, 825 RPM, B/B	FSE1058SF	1870	D713	3746	X452	-	0168	-	-	-	-	R22245
10203	1/6 HP, 208-230 V, 825 RPM, B/B	FE1018SF, FSE1018SF	-	D793	3203	X465	3203	-	-	-	-	-	CF-816
10204	1/4 HP, 208-230 V, 825 RPM, B/B	FE1028SF, FSE1028SF	1874	-	3204	X450	40825	-	-	-	-	S1-FHM3204	CF-814
10205	1/3 HP, 208-230 V, 825 RPM, B/B	FE1038SF, FSE1038SF	1875	-	3205	X451	30825	-	-	-	-	S1-FHM3205	-
10747	1/2 HP, 208-230 V, 825 RPM	F1058	-	-	3736	X452	-	-	-	-	-	-	-
10732	1/6 HP, 208-230 V, 1075 RPM, B/B	FE1016SF	2246	-	3726	X427	-	-	-	-	-	-	CF-3726
10733	1/4 HP, 208-230 V, 1075 RPM, B/B	F1026S, FE1026SF, FSE1026SV1	1876	D7909	3732	X428	43732	-	-	-	-	-	CF-3732
10734	1/3 HP, 208-230 V, 1075 RPM, B/B	F1036S, FE1036S	1877	D7908	3733	X413	43733	-	-	-	-	-	CF-3733
10735	1/2 HP, 208-230 V, 1075 RPM, B/B	F1056S, FE1056SF	1878	D7907	3734	X414	43734	-	-	-	-	-	CF-3734
10736	3/4 HP, 208-230 V, 1075 RPM, B/B	F1076SF, FS1076S	1879	-	3735	-	43735	-	-	-	-	-	CF-3735
10327	1/6 HP, 208-230 V, 1075 RPM	-	8661	D718	3327	-	-	-	W51-16CJA1-01	-	-	-	-
10328	1/4 HP, 208-230 V, 1075 RPM	FS1026S	3851	D823	3328	-	-	-	W51-14CJA1-01	-	-	-	-
10329	1/3 HP, 208-230 V, 1075 RPM	FS1036S	6880	D748/D749	3329	-	-	-	W51-13CJA1-01	-	-	-	-
10330	1/2 HP, 208-230 V, 1075 RPM, B/B	FS1056S	3852	D745/D804	3330	-	-	-	W51-12CJA1-01	-	-	-	-
10331	3/4 HP, 208-230 V, 1075 RPM	FS1076S	3097	D929	3331	-	-	-	-	-	-	-	-
23728	1/4HP 208-230V 1075RPM 3W	FSE1026S	1860	D909	3728	X412	43728	01-0161	W51-14CJA1-01	P257-8728	WG840729	S1-FHM3728	-
23729	1/3HP 208-230V 1075RPM 3W	FSE1036S	1861	D908	3729	X413	43729	01-0162	W51-13CJA1-01	P257-8729	WG840729	S1-FHM3729	-
Multi-Horsepower Condenser Fan													
10458	1/6, 1/5, 1/4, 1/3, 1075 RPM, 208-230 V, WIZ, B/B	ORM5458	5458	-	3458	-	-	-	W51-MHCJA1-01	-	-	-	R22402
10459	1/8, 1/6, 1/5, 1/4, 1/3, 825RPM, 208-230 V, WIZ, B/B	ORM5488B	5464	-	3459	-	-	-	-	-	-	-	-
10465	1/6, 1/5, 1/4, 1/3, 1075 RPM, 208-230 V, B/B	FE6000	5462	D2827	3465	X072	-	01-0695	51-23053-21	P257-E5462	WG840465	S1-FHM3465	R22605
10468	1/5, 1/4, 1/3, 1/2, 1075 RPM, 208-230 V, B/B	FE6002	5465	-	3468	X076	-	01-0697	-	P257-E5465	WG840468	S1-FHM3468	R22602
10469	1/6, 1/5, 1/4, 1/3, 825 RPM, 208-230 V, B/B	FE6001	5464	D2826	3469	-	-	01-0696	51-20760-11	P257-E5464	WG840469	S1-FHM3469	R22601
Direct Drive													
10583	1/4 HP, 115 V, 1075 RPM	DL1026	1863	D721	3583	X000	43583	01-0169	W51-14BAA3-01	P257-8583	WG840583	S1-FHM3583	DD-3583
10584	1/4 HP, 208-230 V, 1075 RPM	D1026	1971	D725	3584	X001	43584	01-0173	W51-14BJA3-01	P257-8584	WG840584	S1-FHM3584	DD-3584
10585	1/3 HP, 115 V, 1075 RPM	DL1036	1864	D727	3585	X002	43585	01-0170	W51-13BAA3-01	P257-8585	WG840585	S1-FHM3585	DD-3585
10586	1/3 HP, 208-230 V, 1075 RPM	D1036	1972	D923	3586	X003	43586	01-0174	W51-13BJA3-01	P257-8586	WG840586	S1-FHM3586	DD-3586
10587	1/2 HP, 115 V, 1075 RPM	DL1056	1865	D701	3587	X004	43587	01-0171	W51-12BAA3-01	P257-8587	WG840587	S1-FHM3587	DD-3587
10588	1/2 HP, 208-230 V, 1075 RPM	D1056	1973	D703	3588	X005	43588	01-0175	W51-12BJA3-01	P257-8588	WG840588	S1-FHM3588	DD-3588
10589	3/4 HP, 115 V, 1075 RPM	DL1076	8904	D728	3589	X009	43589	01-0172	W51-34BAA3-01	P257-8589	WG840589	S1-FHM3589	DD-3589
10590	3/4 HP, 208-230 V, 1075 RPM	D1076	8905	D729	3590	X010	43590	01-0176	W51-34BJA3-01	P257-8590	WG840590	S1-FHM3590	DD-3590
10591	1 HP, 115 V, 1075 RPM	BDL1106	8906	D712	3595	-	-	-	-	-	WG840595	S1-FHM3595	R6-R42812
10592	1 HP, 208-230 V, 1075 RPM	BD1106	8907	D711	3596	X023	48907	-	-	-	WG840596	S1-FHM3596	R6-R42842
10683	1/4 HP, 115 V, 1075 RPM	FML1026	3783	D1730	3783	-	-	-	-	-	-	-	-
10684	1/4 HP, 208-230 V, 1075 RPM	FML1026	3784	D1733	3784	-	-	-	-	-	-	-	-
10685	1/3 HP, 115 V, 1075 RPM	FML1036	3785	D1731	3785	-	-	-	-	-	-	-	-
10686	1/3 HP, 208-230 V, 1075 RPM	FM1036	3786	D1734	3786	-	-	-	-	-	-	-	-
10687	1/2 HP, 115 V, 1075 RPM	FML1056	3787	D1732	3787	-	-	-	-	-	-	-	-
10688	1/2 HP, 208-230 V, 1075 RPM	FM1056	3788	D1735	3788	-	-	-	-	-	-	-	-
10689	3/4 HP, 115 V, 1075 RPM	FML1076V1	-	-	3789	-	-	-	-	-	-	-	-
10690	3/4 HP, 208-230 V, 1075 RPM	FM1076	-	-	3790	-	-	-	-	-	-	-	-

Disclaimer: Every effort has been made to insure the accuracy of motor data and cross reference information. Design changes may result in different operating characteristics or dimensional changes from one manufacturer to another. Therefore, MARS cannot accept responsibility for the ultimate selection. For additional information, please contact MARS.

Note: B/B – Ball Bearing

MARS No.	Description	Century / AO Smith	US Motors/ Emerson	Fasco	GE/ Gentaq	Marathon	Packard	Nordyne/ Partners Choice	Rheem/Ruud Protech	Carrier/ Totaline RCD	Wagner	York Source 1	ROTHM
Multi-Horsepower Direct Drive													
10463	1/6, 1/5, 1/4, 1/3, 1/2 HP, 115 V, 1075 RPM	FDL6001	5460	D2835	3463	X077	-	01-0698	51-23012-41	P257-E5460	WG840463	S1-FHM3463	R43600
10464	1/6, 1/5, 1/4, 1/3, 1/2 HP, 208-230 V, 1075 RPM	FD6000	5461	D833	3464	X073	-	01-0699	51-23022-41	P257-E5461	WG840464	S1-FHM3464	R43601
10466	1/5, 1/4, 1/3, 1/2, 3/4 HP, 115 V, 1075 RPM, B/B	FDL6002	5470	D2832	3466	X074	-	01-0701	51-23017-42	P257-E5470	WG840466	S1-FHM3466	R43602
10467	1/5, 1/4, 1/3, 1/2, 3/4 HP, 208-230 V, 1075 RPM, B/B	FD6001	5471	D2833	3467	X075	-	01-0702	51-23022-41	P257-E5471	WG840467	S1-FHM3467	R43603
10479	1/8, 1/4, 1/3 HP, 825 RPM, 208-230 V	-	5469	-	-	-	-	-	-	-	-	-	-
20538	1/2 HP, 460 V, 1075 RPM, B/B	-	-	-	-	X038	-	-	-	-	-	-	-
20580	1/4, 1/3 HP, 460 V, 1075 RPM, B/B	BDH1036*	-	-	3280	-	-	-	-	-	-	-	M2-R32712
20581	3/4, 1/2 HP, 460 V, 1075 RPM, B/B	BDH1076*	8947	-	3290	-	-	-	-	-	-	-	M2-R32426

MARS No.	Description	Century/ AO Smith	US Motors/ Emerson	Fasco	GE/Gentaq	Rheem/Ruud Protech	Wagner	York Source 1	ROTHM
Sunslinger Condenser Fan 70°C									
20727	1/6 HP Condenser Fan, 208-230 V, 1075 RPM, B/B	FE1016SF	1859H	-	3726HS	-	WG840727HT	-	-
20728	1/4 HP Condenser Fan, 208-230 V, 1075 RPM, B/B	FE1026SF	1860H	-	3732HS	-	WG840728HT	S1-FHM3728HT	-
20729	1/3 HP Condenser Fan, 208-230 V, 1075 RPM, B/B	FE1036SF	1861H	-	3733HS	-	WG840729HT	S1-FHM3729HT	-
20730	1/2 HP Condenser Fan, 208-230 V, 1075 RPM, B/B	FE1056SF	1862H	-	3734HS	-	WG840730HT	S1-FHM3730HT	-
20731	3/4 HP Condenser Fan, 208-230 V, 1075 RPM, B/B	FE1076SF	1868H	-	3735HS	-	WG840731HT	-	-
20402	1/8 HP Condenser Fan, 208-230 V, 825 RPM, B/B	FE1008SF	1872H	-	3202HS	-	-	-	-
20403	1/6 HP Condenser Fan, 208-230 V, 825 RPM, B/B	FE1018SF	1873H	-	3203HS	-	-	-	-
20404	1/4 HP Condenser Fan, 208-230 V, 825 RPM, B/B	FE1028SF	1874H	-	3204HS	-	WG840204HT	S1-FHM3204HT	-
20405	1/3 HP Condenser Fan, 208-230 V, 825 RPM, B/B	FE1038SF	1875H	-	3205HS	-	WG840405HT	S1-FHM3205HT	-
20746	1/2 HP Condenser Fan, 208-230 V, 825 RPM, B/B	FE1058SF	1870H	-	3747HS	-	-	-	-
20846	1/4 HP Condenser Fan, 460 V, 1075 RPM, B/B, Shaft Up	FEH1026S	3736H	D980	3736HS	51-19704-01	WG840736HT	S1-FHM3736HT	R31710
20847	1/3 HP Condenser Fan, 460 V, 1075 RPM, B/B, Shaft Up	FEH1036S	3737H	D982	3737HS	51-23063-11	WG840737HT	S1-FHM3737HT	R31712
20848	1/2 HP Condenser Fan, 460 V, 1075 RPM, B/B, Shaft Up	FEH1056S	3738H	D802	3738HS	51-20929-01	WG840738HT	S1-FHM3738HT	R31718
20849	3/4 HP Condenser Fan, 460 V, 1075 RPM, B/B, Shaft Up	FEH1076S	3739H	-	3739HS	-	WG840739HT	-	-
Sunslinger Multi-Horsepower Condenser Fan 70°C									
20458	1/6, 1/5, 1/4, 1/3 Multi-HP, Condenser Fan, 1075 RPM, 208-230 V, B/B	ORM5458F	3323H	-	3458HS	-	-	-	-
20459	1/8, 1/6, 1/5, 1/4, 1/3 Multi-HP, Condenser Fan, 825RPM, 208-230 V, B/B	ORM5488F	1874H	-	3459HS	-	-	-	-
20465	1/6, 1/5, 1/4, 1/3 Multi-HP, Condenser Fan, 1075 RPM, 208-230 V, B/B	FE6000F	5462H	-	3465HS	-	-	S1-FHM3465HT	-
20468	1/5, 1/4, 1/3, 1/2 Multi-HP, Condenser Fan, 1075 RPM, 208-230 V, B/B	FE6002F	5465H	-	3468HS	-	-	-	-
20469	1/6, 1/5, 1/4, 1/3 Multi-HP, Condenser Fan, 825 RPM, 208-230 V, B/B	FE6002F	5464H	-	3469HS	-	-	S1-FHM3469HT	-
Sunslinger 460V Condenser Fan 70°C									
20859	1/6 HP Condenser Fan, 460 V, 825 RPM, B/B	-	-	-	-	51-101774-06	-	-	R31716
20880	1/4 HP Condenser Fan, 460 V, 825 RPM, B/B	FEH1028S	1880	-	-	51-23064-12	-	-	R22275
20881	1/3 HP Condenser Fan, 460 V, 825 RPM, B/B	-	1881	D960	-	51-100998-26	-	-	R32714
20882	1/2 HP Condenser Fan, 460 V, 825 RPM, B/B	-	1882	D961	-	-	-	-	-
20835	1/6 HP Condenser Fan, 460 V, 1075 RPM, B/B	-	-	-	-	-	-	-	-
20836	1/4 HP Condenser Fan, 460 V, 1075 RPM, B/B	788A, FEH1026SF	3736H	D980	3736	51-19704-01	WG840736HT	S1-FHM3736HT	R31710
20837	1/3 HP Condenser Fan, 460 V, 1075 RPM, B/B	789A, FEH1036SF	3737H	D982	3737	51-23063-11	WG840737HT	S1-FHM3737HT	R31712
20838	1/2 HP Condenser Fan, 460 V, 1075 RPM, B/B	790A, FEH1056SF	3738H	D802	3738	51-20929-01	WG840738HT	S1-FHM3738HT	R31718
20842	3/4 HP Condenser Fan, 460 V, 1075 RPM, B/B	FEH1076SF	3742H	-	3739	-	WG840739HT	-	-
Sunslinger 460V Multi-Horsepower Condenser Fan 70°C									
20478	1/5, 1/4, 1/3, 1/2 Multi-HP, Condenser Fan, 1075 RPM, 460 V, B/B	ORM4658BF	-	-	-	-	-	-	-
20479	1/6, 1/5, 1/4, 1/3, Multi-HP, Condenser Fan, 1075 RPM, 460 V, B/B	ORM4659BF	-	-	-	-	-	-	-
20480	1/6, 1/5, 1/4, 1/3, 1/2 Multi-HP, Condenser Fan, 1075 RPM, 460 V, B/B	-	5480H	-	-	-	-	-	-
20481	3/4, 1/2, 1/3, 1/4 Multi-HP, Condenser Fan, 1075 RPM, 460 V, B/B	-	5481H	-	-	-	-	-	-
Sunslinger MAX Condenser Fan 80°C									
20791	3/4 HP Condenser Fan, 208-230 V, 1075 RPM, B/B	FE1076SU	-	-	-	-	-	-	-
20796	3/4 HP Condenser Fan, 208-230 V, 825 RPM, B/B	-	-	-	-	-	-	-	-

Disclaimer: Every effort has been made to insure the accuracy of motor data and cross reference information. Design changes may result in different operating characteristics or dimensional changes from one manufacturer to another. Therefore, MARS cannot accept responsibility for the ultimate selection. For additional information, please contact MARS.

Note: B/B – Ball Bearing
* 2 Speed Motor



Toll Free (800) 445-4155 • Fax (631) 348-7160
www.marsdelivers.com

WARNING:
Cancer and Reproductive Harm
www.P65Warnings.ca.gov

Cross Reference / MARS Motors

MARS No.	Description	Century/ AO Smith	US Motors/ Emerson	Fasco	Genteq	Magnetek	Marathon	Packard	Rheem/Ruud	ROTOM	Wagner
High Efficiency Direct Drive Motors											
10573	1/4 HP Direct Drive, 115V, 1075 RPM	DL1026, FDL1026	5460, 1863	D721, D2836	3983, 3583	0533	X000	43583, 63983	51-17947-11, 51-23012-41, 51-23014-32	R43600	WG840463, WG840583
10574	1/4 HP Direct Drive, 208-230V, 1075 RPM	D1026, FD1026	5461, 1971	D725	3984, 3584	0530	X001	43884, 63984	51-23022-41, 51-23024-31	DD3584, R43584	WG840584
10575	1/3 HP Direct Drive, 115V, 1075 RPM	DL1036, FDL1036	5460, 1864	D727	3985, 3585	0532	X002	43585, 63985	-	-	-
10576	1/3 HP Direct Drive, 208-230V, 1075 RPM	D1036, FD1036	5461, 1972	D923	3986, 3586	0529	X003	43586, 63986	-	-	-
10577	1/2 HP Direct Drive, 115V, 1075 RPM	DL1056, FDL1056	5460, 1865	D701	3987, 3587	0531	X004	43587, 63987	-	-	-
10578	1/2 HP Direct Drive, 208-230V, 1075 RPM	D1056, FD1056, F1076SV1	5461, 1973	D703	3988, 3588	0528	X005	43588, 63988	-	-	-
10579	3/4 HP Direct Drive, 115V, 1075 RPM	DL1076, FDL1076	5470, 8904	D728	3989, 3589	0678	X009	43589, 63989	-	-	-
10580	3/4 HP Direct Drive, 208-230V, 1075 RPM	D1076, FD1076	5471, 8905	D729	3990, 3590	0679	X010	43590, 63990	-	-	-

MARS No.	Description	Century/ AO Smith	Baldor	US Motors/ Emerson	Leeson	Marathon
Commercial Condenser Fan - Three Phase - Rigid Base						
10513	1HP 1140 RPM 208-230/460 CF	H1050A	-	1820H	-	X513
10523	1-1/2HP 1140 RPM 208-230/460V	H1051A	CFM3166A	1821H	111148	X523
10531	1-1/2 HP 850 RPM 208-230/460 CF	H1054A	-	1831H	-	X531
10533	1/2 HP 1140 RPM 208-230/460 CF	-	-	-	-	X533

MARS No.	Description	Century/ AO Smith	Baldor	US Motors/ Emerson	Fasco	KeepRite	Magnetek	Marathon
Commercial Condenser Fan - Three Phase - Belly Band								
10502	1 HP 1140 RPM 208-230/460 CF	FC3106F	CFM3156A	1818H	-	-	H667	X502
10503	1-1/2 HP 1140 RPM 208-230/460	H1051A	CFM3166A	1819H	D6610	-	H767	X503
10507	1 HP 850 RPM 208-230/460 CF	H1053A	-	1828H	-	-	H686	X507
10509	2 HP 1140 RPM 208-230/460 CF	H698	-	-	-	-	-	X509
10530	1-1/2 HP 85 ORPM 208-230/460 CF	H1054A	-	1832H	-	-	-	X530

MARS No.	Description	Century/ AO Smith	Baldor	US Motors/ Emerson	Genteq	Magnetek	Marathon
1 Phase Heating - Split Phase Fan & Blower							
10302	1/4 HP 1725RPM 115V FAN & BLWR	919L	-	DB14B2N49	-	919	B302
10303	1/4 HP 1725RPM 115V FAN & BLWR	920L, GF2024	RSP1441A	8000, 3618	4701, 4730	808	B303, B206
10304	1/3 HP 1725RPM 115V FAN & BLWR	921L, RB2034L	-	D13B2N4Z9	-	921	B304
10305	1/3 HP 1725RPM 115V FAN & BLWR	922L, RB2034	-	8100	-	922	B305, B207
10306	1/2 HP 1725RPM 115V FAN & BLWR	-	-	D12C2J49	-	-	B306
10307	1/2 HP 1725RPM 115V FAN & BLWR	GF2054	RSP3451A	8200, PD6006	4708, 4733	-	B307

MARS No.	Description	Century/ AO Smith	Baldor	US Motors/ Emerson	Fasco	Leeson	Magnetek	Marathon
1 Phase Heating - Cap Start Fan & Blower								
10313	1/4 HP 1725 RPM 115/208-230V	C196L	RL1203A	D14CA2P4Z9	-	100109.00	C196	B313
10315	1/3 HP 172 5RPM 115/208-230V	RBF1034A	-	D13CA3J9	-	-	-	B315
10317	1/2 HP 1725 RPM 115/208-230V	BK1054, C412V1	-	D12CA2J9	D6084	100011.00	-	B317
10319	3/4 HP 1725 RPM 115/208-230V	C426V1, RB1074A	RL1307A	D34CA2JH9	-	100012.00	-	B319
10321	1 HP 1725 RPM 115/208-230V	C523V1	RL1310A	D1CA2JH9	D6088	110007.00	-	4688

Disclaimer: Every effort has been made to insure the accuracy of motor data and cross reference information. Design changes may result in different operating characteristics or dimensional changes from one manufacturer to another. Therefore, MARS cannot accept responsibility for the ultimate selection. For additional information, please contact MARS.

Note: B/B – Ball Bearing

MARS No.	Description	Century/ AO Smith	US Motors/ Emerson	Marathon
Oil Burner Motors				
30004	1/4 HP 115V 3450 RPM	EL2022	2302	O004
30011	1/2 HP 115/230 3450 RPM	-	3267	O011
30100	1/7 HP 115V 3450 RPM	EL2002	3083	O100
30600	1/8 HP 115V 1725 RPM	EL2005	3196	O600
30601	1/6 HP 115V 1725 RPM	XEL2014	3252	O601
30701	1/7 HP 115V 3450 RPM	-	3247	O701

MARS No.	Description	Century/ AO Smith	US Motors/ Emerson	Marathon
Unit Heater - PSC, TEAO				
30301	1/6 HP 1075RPM 115 UNIT HTR	UH1016, US1016	1386	X302
30303	1/4 HP 1075RPM 115 UNIT HTR	566A, UH1026	1384	X303
30305	1/3 HP 1075RPM 115 UNIT HTR	UH1036	1388	X304

MARS No.	Description	Replaces	Azure®	Century/ AO Smith	US Motors/ Emerson	GE/Genteq
Azure® ECM Direct Drive						
10860	1/5-1/2 HP, Direct Drive ECM, 115/230 V, 1075 RPM, B/B	X13, PSC	10800	Comfort Select: CS1056, CSL1056	Rescue Ecotech: 5522ET, 5532ET, 5542ET (1/3HP & 1/2HP), 5552ET (1/2HP), 6631RS (1/2-1/3HP), 6630RS (1/2-1/3HP)	6001, 6002, 6005, 6103E, 6203E, 6105E, 6205E
10861	1/2-1 HP, Direct Drive ECM, 115/230 V, 1075 RPM, B/B	X13, PSC	10801	Comfort Select: CS1106, CSL1106	Rescue Ecotech: 5552ET, 5542ET (3/4HP), 6651RS (1HP), 6641RS (3/4HP), 6650RS (1HP), 6640RS (3/4HP)	6003, 6004, 6010, 6107E, 6207E, 6110E, 6210E
10867	1/8-1/3 HP, Direct Drive ECM, 115/230/277 V, 1075 RPM, B/B	5" PSC Direct Drive	-	-	-	-
10865	AZURE 1/3 - 1/2 HP ECM D/D	PSC	-	-	Rescue Ecotech 5522ET, 5532ET	Evergreen 6005
10866	AZURE 3/4 - 1 HP ECM D/D	PSC	-	-	Rescue Ecotech 5542ET, 5552ET	Evergreen 6010
10858	1/5-1/2 HP AZURE FOR X13	X13, Ensite, Endura	-	-	Rescue EZ13 5632, Rescue Select Pro 6633	Evergreen 6103E, 6203E, 6105E, 6205E
10859	1/2-1 HP AZURE FOR X13	X13, Ensite, Endura	-	-	Rescue EZ13 5642, EZ13 5652, Rescue Select Pro 6643, 6653	Evergreen 6107E, 6207E, 6110E, 6210E
10856	AZURE VS 1/4-1/2 HP D/D	Variable Speed	-	-	Rescue EZ16 5862, EZ5863	Evergreen 6503V, 6505V, Interface Board 56010
10857	Azure VS 1/2 to 1 HP D/D	Variable Speed	-	-	Rescue EZ16 5860, EZ16 5861	Evergreen 6507V, 6510V, Interface Board 56010

MARS No.	Description	Replaces
Azure® ECM Condenser Fan		
10874	1/8 - 1/3 HP, Condenser Fan ECM, 208-230 V, 825/1075 RPM, B/B	PSC motors 1/8 to 1/3 HP
10875	1/8 - 1/3 HP, Condenser Fan ECM, 208-230 V, 1075 RPM, B/B	PSC motors 1/8 to 1/3 HP
10872	1/3 - 1/2 HP, Condenser Fan ECM, 208-230 V, 1075 RPM, B/B	PSC motors 1/3 to 1/2 HP

MARS No.	Description	Replaces	Bohn	Regal Beloit/Morrill	Wellington	US Motors
Azure® ECM 3.3" Commercial Refrigeration						
10850	1/15-1/25 HP, 3.3" Commercial Refrigeration ECM, 115/230 V, 1550/800 RPM, B/B	-	-	5100, 5105, 5106, 5101, 5111, 5200, 5201, 5205, 5206, 5211	ECR 85/95	EC5404D, EC5405D
10852	1/15-1/25 HP, 3.3" Commercial Refrigeration ECM, 115/230 V, 1550 RPM, B/B	Standard 3.3" motors	5008S, 5008T	5100, 5101, 5102, 5105, 5106, 5111, 5200, 5201, 5205, 5206, 5211	-	EC5404D, EC5405D

MARS No.	Description	Replaces	MARS	Century Motor	Hussmann	Morrill	US Motors Rescue
Azure® Commercial Refrigeration Watt (Reach-In) Motor							
10891	4-25 Watts, Commercial Refrigeration ECM, 115/230 V, 1550 RPM, B/B	All standard watt motors: 4-25 W	10890	9207F2, 9208F2, 9211, 9212, 9213	4410547	5R999	EC5411D, EC5412D

Disclaimer: Every effort has been made to insure the accuracy of motor data and cross reference information. Design changes may result in different operating characteristics or dimensional changes from one manufacturer to another. Therefore, MARS cannot accept responsibility for the ultimate selection. For additional information, please contact MARS.

Note: B/B – Ball Bearing



Toll Free (800) 445-4155 • Fax (631) 348-7160
www.marsdelivers.com



Cross Reference / MARS Motors

MARS No.	Description	Century/ AO Smith	US Motors/ Emerson	GE/Genteq	Magnetek	Marathon	Packard	ROTOM
Belted Fan & Blower								
10401	1/4 HP, Belted Fan & Blower, 115 V, 1725 RPM	GF2024, RB2024	2889, 8000	4701	808, 802	B303, B206	45014	BF-4701
10406	1/3 HP, Belted Fan & Blower, 115 V, 1725 RPM	GF2034, RB2034	2888, 8100	4706	922, 805	B305, B207	45013	BF-4706
10408	1/2 HP, Belted Fan & Blower, 115 V, 1725 RPM	GF2054, BF2054	2887, 8200	4708	F681, 811	B208	45012	BF-4708

MARS No.	Description	Century/ AO Smith	US Motors/ Emerson	Fasco	GE/Genteq	Magnetek
21/29 Frame Replacement Commercial Refrigeration						
10611	1/20 HP, Commercial, 115/230 V, 1550 RPM	-	F1468	D484, D485	2331, 2332, 2341, 2342	610, 611
10615	1/10 HP, Commercial, 115/230 V, 1550 RPM	329P118, 326P119, RF4400, RF4401	F1469, F1470	D480, D481, D482, D483	2131, 2132, 2141, 2142, 2231, 2232, 2241, 2242	614, 615, 612, 613

MARS No.	Description	Century/ AO Smith	US Motors/ Emerson	Fasco	GE/Genteq	Heil Quaker	York Source 1
Super-Fit™ Multi-Horsepower Condenser Fan							
10722	1/8, 1/10, 1/12 HP, Multi-HP, Condenser Fan, 208-230 V, 1075 RPM, B/B	9722	5440*	-	5KCP29DCA323S, 5KCP29ECA328S, 5KCP29DCA329S, 5KCP29FCA322S, 02243, 02248, 02249, 02251	-	17416, 17465, 17483, 17484
10723	1/4, 1/5, 1/6 HP, Multi-HP, Condenser Fan, 208-230 V, 1075 RPM, B/B	9723	5441*, 1901	D1071	5KCP29JCA324S, 5KCP29JCA325S, 5KCP29HCA326S, 5KCP29JCA327S, 5KCP29ECA321S, 02244, 02245, 02246, 02247, 02250	HQ1052662EM	-
10724	1/4, 1/5, 1/6 HP, Multi-HP, Condenser Fan, 208-230 V, 1675 RPM, B/B	9724	-	-	-	-	-

*70°C Heat Shield

MARS No.	Description	Century/ AO Smith	US Motors/ Emerson	Fasco	GE/Genteq	Packard
3.3" Multi-Horsepower Commercial Refrigeration						
01125	1/12, 1/15, 1/18 HP, Evap Fan Motor, 208-230 V, 1550 RPM	9720A	9656, 8658, 9664	7190-0442, D1125	-	41125
01127	1/12, 1/15, 1/20 HP, Evap Fan Motor, 115/230 V, 1550 RPM	9721	9650, 9651, 9652, 9653, 9656, 9662, 9664	D1101, D1103, D1122, D1123, D1124, D1125, D1126, D1127, D1152, D1154, PD1125, PD1127, 7163-2113, 7163-3371 7190-0442, 7190-2084, 7190-2255, 7190-2285, 7190-2969	5KSM59ES2001 5KSM59JSK143S 5KSM59JS5036S 5KSM59LS2262AS	49101

MARS No.	Description	Century/ AO Smith	US Motors/ Emerson	Fasco	Magnetek	Packard	RMR
3.3" Commercial Refrigeration							
09916	1/30 HP, Evap Fan Motor, 115 V 1550 RPM	AO126, AO127	-	D532, D181	28, 29	-	RR-1106
09917	1/20 HP, Evap Fan Motor, 115 V 1550 RPM	AO132, AO133	-	D132	572, 574, 30, 31	40132	RR-1107
09927	1/20 HP, Evap Fan Motor, 208-230 V 1550 RPM	AO188, AO189	-	D188, D189	575	40188	RR-4107
09938	1/30 HP, Evap Fan Motor, 115 V 1550 RPM	-	9656	D1125	-	-	-

MARS No.	Description	Century/ AO Smith	Fasco	GE	Magnetek/UE
Fan Coil Replacement Motor					
10889	1/10 HP, 115 V 1050 RPM	DBL6409	D289	2089	89

Disclaimer: Every effort has been made to insure the accuracy of motor data and cross reference information. Design changes may result in different operating characteristics or dimensional changes from one manufacturer to another. Therefore, MARS cannot accept responsibility for the ultimate selection. For additional information, please contact MARS.

Note: B/B – Ball Bearing



One-On-One™ Replacement Motors

MARS No.	Description	Copeland	US Motors/Emerson	GE/Genteq	Packard
One-On-One™ Replacement Motor for Copeland					
10227	1/3 HP, Condenser Fan, 208-230 V, 1625 RPM	050-0108-00	6127, K55HXECE2645	5KCP32KG2598, 5KCP32KG175	-
10228	1/6 HP, Condenser Fan, 208-230 V, 1550 RPM	050-0251-00	6128, K55HSJNG-2974	5KCP32KG221	40251
10229	1/4 HP, Condenser Fan, 208-230 V, 1625 RPM	050-0250-00	6129, K55HXJZJ-3126		40250
10264	1/4 HP, Condenser Fan, 230 V, 1550 RPM	050-0238-00, 050-0107-01	6124, K55BZY-1439	5KCP39GG357S	-
10265	1/6 HP, Condenser Fan, 208-230 V, 1550 RPM	050-0265-00	K55PGP5104		40265

MARS No.	Description	Carrier
10234	1/10 HP, 208-230 V, 1100/1, CW OSE	HC33GE233
MARS USA, 5-1/2 inch diam., totally enclosed, ball bearing, capacitor required 5 MFD @ 370V (MARS No. 12005, 12905, 14005), CW Shaft End		

MARS No.	Description	Goodman
10230	1/4 HP, 208-230 V, 1100/1, CCW OSE	0131M00019P
MARS USA, 5-1/2 inch diam., totally enclosed, ball bearing, capacitor required 5 MFD @ 370V (MARS No. 12005, 12905, 14005), CCW Shaft End		
10232	1/6 HP, 208-230 V, 810/1 CCW OSE	0131M00060
MARS USA, 5-1/2 inch diam., totally enclosed, ball bearing, capacitor required 5 MFD @ 370V (MARS No. 12005, 12905, 14005), CCW Shaft End		
03242	1/6 HP, 208-230 V, 1075/1 CCW OSE	G3911
MARS USA, 5 1/2 inch diam. Totally enclosed, ball bearing, capacitor required 5 MFD @ 370V (MARS No. 12005, 12905, 14005), CCW Shaft End		
10233	1/8 HP, 208-230 V, 1050/1 CCW OSE	0131M00294
MARS USA, 5-1/2 inch diam., totally enclosed, ball bearing, capacitor required 5 MFD @ 370V (MARS No. 12005, 12905, 14005), CCW Shaft End		
10594	1/2 HP, 115 V, 1130/4 CW OSE	0131F00022
MARS USA, 5-1/2 inch diam., totally enclosed, ball bearing, capacitor required 20 MFD @ 370V (MARS No. 12014, 12914, 14014), CW Shaft End		

MARS No.	Description	York Source 1
10570	1/3 HP, 575/1/60, 850 RPM, CCW OSE	S1-02434550003
5-1/2 inch diam., totally enclosed, ball bearing, capacitor required, 5 MFD @ 370V (MARS No. 12005, 12905, 14005), CCW OSE		
10571	3/4 HP, 575/1/60, 1100 RPM, CCW OSE	S1-02434551003
5-1/2 inch diam., totally enclosed, ball bearing, capacitor required, 10 MFD @ 440V (MARS No. 12032, 12932, 14032), CCW OSE		

Sunslinger One-On-One™ Replacement Motor

MARS No.	Description	Century/AO Smith
20884	1/8, 1/6, 1/5, 1/4, 1/3 HP, 460 V, 825/1 Reversible	ORM4688BF
5-1/2 inch diam., totally enclosed, ball bearing, capacitor required 7.5 MFD @ 370V (MARS No. 12007, 12907, 14007), Reversible		

Disclaimer: Every effort has been made to insure the accuracy of motor data and cross reference information. Design changes may result in different operating characteristics or dimensional changes from one manufacturer to another. Therefore, MARS cannot accept responsibility for the ultimate selection. For additional information, please contact MARS.

Note: B/B – Ball Bearing



Toll Free (800) 445-4155 • Fax (631) 348-7160
www.marsdelivers.com



Unit Bearing / Condenser Fan Motors

Unit Bearing Motors

JARD Unit Bearing Cast Iron Motors are used on refrigerators, freezers, food & beverage coolers, vending machines, display cases, and many other fan duty applications.

Features:

- Cast iron construction
- Universal mount
- Mounting screws included
- Individually boxed

Specifications:

- Class "A" insulation
- UL Recognized



MARS NO.	WATTS	VOLTAGE	ROTATION	AMPS	LEAD LENGTH
15109	2	115	CW	0.28	24"
15211	4	115	CW	0.33	24"
15212	4	115	CCW	0.33	24"
15221	4	230	CW	0.19	24"
15222	4	230	CCW	0.19	24"
15311	6	115	CW	0.46	24"
15312	6	115	CCW	0.46	24"
15119*	9	115	CW	0.62	13"
15411	9	115	CW	0.62	24"
15412	9	115	CCW	0.62	24"
15421	9	230	CW	0.33	24"
15422	9	230	CCW	0.33	24"
15811	16	115	CW	0.95	24"
15812	16	115	CCW	0.95	24"
15821	16	230	CW	0.48	24"
15822	16	230	CCW	0.48	24"

* Note: 13" lead with lyall plug

Condenser Fan Motors

Ball Bearing

JARD replacement condenser fan motors are designed for residential and light commercial HVAC/R applications suitable for either vertical shaft-up or shaft-down mounting. Shell and end shields are enclosed for weather protection. A weep hole is provided in each end shield to allow condensate to drain.

Features:

- All angle, sleeve or ball bearing
- Rheem mounting holes w/screws
- Reversible rotation
- Thru bolt or band mounting
- Capacitor requirement noted on motor label
- Up/Down design

Specifications:

- Class "B" insulation
- Single phase, 60 Hz
- Thermal overload protected
- Fan duty, continuous air over
- 26 & 36 inch leads
- UL Recognized

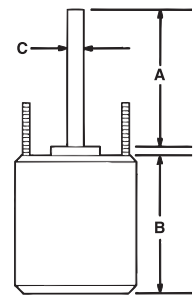

Reversible Rotation – Single Speed

MARS NO.	HP	VOLTS	AMPS	CAP REQ.	ENCL.	BRG.	DIMENSIONS			LEAD LENGTHS
							A	B	C	
1075 RPM										
22727	1/6	208-230	0.90	5/370	TEAO	Ball	6.50	4.23	1/2	26"
22728	1/4	208-230	1.8	5/370	TEAO	Ball	6.50	4.23	1/2	26"
22729	1/3	208-230	2.4	7.5/370	TEAO	Ball	6.50	5.23	1/2	26"
22730	1/2	208-230	3.5	10/370	TEAO	Ball	6.50	5.73	1/2	26"
22731	3/4	208-230	5.2	10/370	TEAO	Ball	6.50	6.23	1/2	30.5"

MARS NO.	HP	VOLTS	AMPS	CAP REQ.	ENCL.	BRG.	DIMENSIONS			LEAD LENGTHS
							A	B	C	
825 RPM										
22403	1/6	208-230	1.0	5/370	TEAO	Ball	6.50	4.23	1/2	36"
22404	1/4	208-230	1.6	5/370	TEAO	Ball	6.50	4.48	1/2	36"
22405	1/3	208-230	1.9	7.5/370	TEAO	Ball	6.50	5.23	1/2	36"
22746	1/2	208-230	2.8	12.5/370	TEAO	Ball	6.50	5.70	1/2	36"

Direct Drive Blower Motors



JARD direct drive blower motors are ideal for use in commercial and residential furnaces and air-conditioners. All models are three speed standard efficiency and are electrically reversible.

Features:

- All angle sleeve bearing
- Rheem mounting holes
- 3 speeds
- 1/2 inch extended thru bolts
- 2-1/4 inch resilient rings
- 4 inch long, 1/2 inch diameter shaft

Specifications:

- Class "B" insulation
- Single phase, 60 Hertz
- Thermal overload protected
- Fan duty, continuous, air over
- Open construction
- 26 & 30 inch leads
- UL Recognized

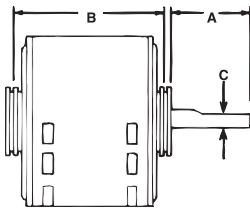

1075 RPM – Three Speed – Reversible Rotation

MARS NO.	HP	ROT	VOLTS	AMPS	CAP REQ.	ENCL.	BRG.	DIMENSIONS			LEAD LENGTHS
								A	B	C	
22583	1/4	Rev	115	4.2	5/370	OAO	Sleeve	4.50	4.89	1/2	26"
22584	1/4	Rev	208-230	1.8	5/370	OAO	Sleeve	4.50	4.89	1/2	26"
22585	1/3	Rev	115	6.1	5/370	OAO	Sleeve	4.50	5.14	1/2	30"
22586	1/3	Rev	208-230	2.7	5/370	OAO	Sleeve	4.50	5.14	1/2	26"
22587	1/2	Rev	115	7.5	10/370	OAO	Sleeve	4.50	5.89	1/2	30"
22588	1/2	Rev	208-230	3.2	7.5/370	OAO	Sleeve	4.50	5.64	1/2	30"
22589	3/4	Rev	115	11.2	15/370	OAO	Sleeve	4.50	6.14	1/2	30"
22590	3/4	Rev	208-230	4.5	10/370	OAO	Sleeve	4.50	6.14	1/2	30"

Multi-Horsepower Direct Drive Motors



JARD multi-horsepower direct drive blower motors are used in residential and commercial furnaces, air conditioners, exhaust fans, and other air handling equipment installed in clean and dry environments. Four models cover both 115 and 208-230 volt applications from 1/6 through 3/4 HP. All models feature Rheem shell mounting holes.

Features:

- Rheem mounting holes
- Reversible rotation
- 2-1/4 inch resilient rings

Specifications:

- Class "B" insulation
- Single phase, 60 Hz
- Thermal overload protected
- 41 inch leads
- UL Recognized

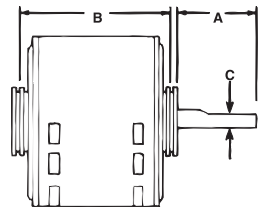

1075 RPM - Four Speed - Reversible Rotation

MARS NO.	HP	ROT	VOLTS	ENCL.	BRG.	DIMENSIONS			LEAD LENGTHS
						A	B	C	
22463	1/6 - 1/2	Rev	115	OAO	Sleeve	5.50	4.73	1/2	42"
22464	1/6 - 1/2	Rev	230	OAO	Sleeve	5.50	4.73	1/2	41"
22466	1/5 - 3/4	Rev	115	OAO	Ball	5.80	5.73	1/2	41"
22467	1/5 - 3/4	Rev	230	OAO	Ball	4.60	5.23	1/2	41"

Tech Tip

Motor leads are for carrying electrical current, only. Carrying your motor by the leads may cause internal damage to the motor.

Multi-Horsepower Motors / Condenser Fan Motors

Multi-Horsepower Condenser Fan Motors

Ball Bearing

JARD multi-horsepower condenser fan motors are designed for either shaft up or shaft down applications. All motors are suitable for air conditioning or heat pump applications. These motors need to be mounted within the airflow of the fan for proper cooling.

Features:

- Rheem mounting holes w/screws installed
- Thru bolt or band mounting
- Water slinger on shaft
- Air conditioning or heat pump duty

Specifications:

- Class "B" insulation
- Single phase, 60 Hz
- Thermal overload protected
- UL Recognized

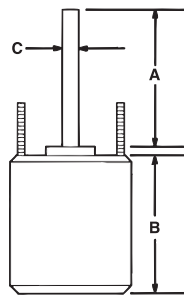

Reversible Rotation – Single Speed

MARS NO.	HP	ROT	RPM/SPEED	VOLTS	ENCL.	BRG.	DIMENSIONS			LEAD LENGTHS
							A	B	C	
22458	1/6 - 1/3	Rev	1075	208-230	TEAO	Ball	6.50	3.82	1/2	36"
22459	1/8 - 1/3	Rev	825	208-230	TEAO	Ball	6.50	5.48	1/2	36"
22465	1/6 - 1/3	Rev	1075/2	208-230	TEAO	Ball	5.00	4.73	1/2	38"
22468	1/8 - 1/2	Rev	1075/2	208-230	TEAO	Ball	5.00	5.48	1/2	38"
22469	1/6 - 1/3	Rev	825/2	208-230	TEAO	Ball	5.00	5.48	1/2	42"

Condenser Fan Motors

Ball Bearing

JARD replacement condenser fan motors are designed for residential and light commercial HVAC/R applications suitable for either vertical shaft-up or shaft-down mounting. Shell and end shields are enclosed for weather protection. A weep hole is provided in each end shield to allow condensate to drain.

Features:

- All angle, ball bearing
- Rheem mounting holes w/screws
- Reversible rotation
- Thru bolt or band mounting
- Capacitor requirement noted on motor label
- Up/Down design
- 48" Leads

Specifications:

- Class "B" insulation
- Single phase, 60 Hz
- 70°C, 158°F
- Thermal overload protected
- Fan duty, continuous air over
- UL Recognized

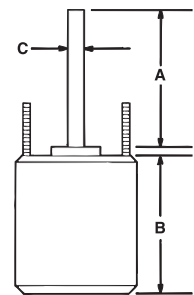

Reversible Rotation – Single Speed

MARS NO.	HP	VOLTS	AMPS	CAP REQ.	ENCL.	BRG.	DIMENSIONS		
							A	B	C
1075 RPM									
26726	1/5	208-230	0.90	5/370	TEAO	Ball	6.50	4.23	1/2
26727	1/6	208-230	0.90	5/370	TEAO	Ball	6.50	4.23	1/2
26728	1/4	208-230	1.8	5/370	TEAO	Ball	6.50	4.23	1/2
26729	1/3	208-230	2.4	7.5/370	TEAO	Ball	6.50	5.23	1/2
26730	1/2	208-230	3.5	10/370	TEAO	Ball	6.50	5.73	1/2
26731	3/4	208-230	5.2	10/370	TEAO	Ball	6.50	6.23	1/2

MARS NO.	HP	VOLTS	AMPS	CAP REQ.	ENCL.	BRG.	DIMENSIONS		
							A	B	C
825 RPM									
26403	1/6	208-230	1.0	5/370	TEAO	Ball	6.50	4.23	1/2
26404	1/4	208-230	1.6	5/370	TEAO	Ball	6.50	4.48	1/2
26405	1/3	208-230	1.9	7.5/370	TEAO	Ball	6.50	5.23	1/2
26746	1/2	208-230	2.8	12.5/370	TEAO	Ball	6.50	5.70	1/2

Multi-Horsepower Condenser Fan Motors

Ball Bearing

JARD multi-horsepower condenser fan motors are designed for either shaft up or shaft down applications. All motors are suitable for air conditioning or heat pump applications. These motors need to be mounted within the airflow of the fan for proper cooling.

Features:

- Rheem mounting holes w/screws installed
- Thru bolt or band mounting
- Water slinger on shaft
- Air conditioning or heat pump duty
- 48" Leads

Specifications:

- Class "B" insulation
- Single phase, 60 Hz
- 70°C, 158°F
- Thermal overload protected
- UL Recognized

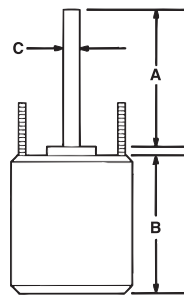

MARS NO.	HP	ROT	RPM/SPEED	VOLTS	ENCL.	BRG.	DIMENSIONS		
							A	B	C
26458	1/6 - 1/3	Rev	1075	208-230	TEAO	Ball	6.50	3.82	1/2
26459	1/8 - 1/3	Rev	825	208-230	TEAO	Ball	6.50	5.48	1/2
26465	1/6 - 1/3	Rev	1075/2	208-230	TEAO	Ball	5.00	4.73	1/2
26468	1/8 - 1/2	Rev	1075/2	208-230	TEAO	Ball	5.00	5.48	1/2
26469	1/6 - 1/3	Rev	825/2	208-230	TEAO	Ball	5.00	5.48	1/2

JARD Cross Reference:

JARD NO.	ECONOMASTER	SMART ELECTRIC	WAGNER/DIVERSITECH	PACKARD	US MOTORS/EMERSON
22403	EM3403	-	-	60825	1873
22404	EM3404	SE3338	WG840204	40825	1874
22405	EM3405	SE3339	WG840205	30825	1875
22746	EM3746	-	-	-	1870
22727	EM3727	SE3727	WG840727	43727	1859
22728	EM3728	SE3728	WG840728	43728	1860
22729	EM3729	SE3729	WG840729	43729	1861
22730	EM3730	SE3730	WG840730	43730	1862
22731	EM3731	SE3731	WG840731	43731	1868
22583	EM3583	SE3583	WG840583	43583	1863
22584	EM3584	SE3584	WG840584	43584	1971
22585	EM3585	SE3585	WG840585	43585	1864
22586	EM3586	SE3586	WG840586	43586	1972
22587	EM3587	SE3587	WG840587	43587	1865
22588	EM3588	SE3588	WG840588	43588	1973
22589	EM3589	SE3589	WG840589	43589	8904
22590	EM3590	SE3590	WG840590	43590	8905
22463	EM3463	SE3463	WG840463	45460	5460
22464	EM3464	SE3464	WG840464	45461	5461
22466	EM3466	SE3466	WG840466	45470	5470
22467	EM3467	SE3467	WG840467	45471	5471
22458	EM3458	-	-	45458BF	5458
22459	EM3459	-	-	45488BF	5464
22465	EM3465	SE3465	WG840465	45458B	5462
22468	EM3468	SE3468	WG840468	-	5465
22469	EM3469	SE3469	WG840469	-	5464
26726	-	-	-	-	-
26727	EM3727	-	WG840727	43727	1859
26728	EM3728	-	WG840728	43728	1860
26729	EM3729	-	WG840729	43729	1861
26730	EM3730	-	WG840730	43730	1862
26731	EM3731	-	WG840731	43731	1868
26403	EM3403	-	-	60825	1873
26404	EM3404	-	WG840204	40825	1874
26405	EM3405	-	WG840205	30825	1875
26746	EM3746	-	-	-	1870
26458	EM3458	-	-	-	5458
26459	EM3459	-	-	-	5464
26465	EM3465	-	WG840465	-	5462
26468	EM3468	-	WG840468	-	5465
26469	EM3469	-	WG840469	-	5464

EM&S ESP-L Shaded Pole Motors

Features:

- Cast iron unit bearing
- Single speed
- End or side pad mounting
- Horizontal operation
- With flatted smooth shaft

Specifications:

- Single phase, 60 Hertz
- Overload protection
- Continuous, air over

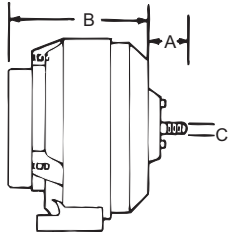

For Tecumseh – Replaces No. 810M050A62

MARS NO.	EMS NO. ESP	WATTS OUTPUT	VOLTS	AMPS	RPM	ROT LE	DIMENSIONS			SHAFT TYPE
							A	B	C	
00507	OL50EMJR21	50	230	0.85	1500	CCW	2.00	4.25	5/16	with flat

For Kelvinator – Replaces Nos. 24-0366, ESP-L15EMJR11

MARS NO.	EMS NO. ESP	WATTS OUTPUT	VOLTS	AMPS	RPM	ROT LE	DIMENSIONS			SHAFT TYPE
							A	B	C	
00152	OL15EMJR11	15	115	0.60	1500	CCW	7.00	3.50	5/16	with flat

EM&S High Efficiency ESP-L Shaded Pole and PSC Motors



The ESP line of motors is a unique and patented design that makes possible a higher output in a smaller frame.

Features:

- Cast iron unit bearing
- Single speed
- End or side pad mounting
- Horizontal operation
- Threaded or smooth shaft
- Heat isolated oil pump and reservoir

Specifications:

- Single phase, 60 Hertz
- 22" leads
- Overload protection
- Continuous, air over

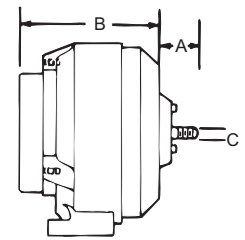

1550 RPM – 1/4" Threaded Shaft

MARS NO.	EMS NO. ESP	WATTS OUTPUT	VOLTS	AMPS	ROT OSE	DIMENSIONS		
						A	B	C
00251	L25EM1	25	115	1.1	CW	.50	3.50	1/4
00253	L25EM2	25	230	0.60	CW	.50	3.50	1/4
00351	L35EM1	35	115	1.4	CW	.50	3.50	1/4
00352	L35EMR1	35	115	1.4	CCW	.50	3.50	1/4
00353	L35EM2	35	230	0.70	CW	.50	3.50	1/4
00354	L35EMR2	35	230	0.70	CCW	.50	3.50	1/4

1550 RPM – 3/8" & 5/16" Smooth Flatted Shaft

MARS NO.	EMS NO. ESP	WATTS OUTPUT	VOLTS	AMPS	ROT OSE	DIMENSIONS		
						A	B	C
00501	OL50EM1	50	115	1.7	CW	1.50	4.50	3/8
00502	OL50EMR1	50	115	1.7	CCW	1.50	4.50	3/8
00505	OL50EM2B	50	230	0.85	CW	1.50	4.50	5/16
00503	OL50EM2	50	230	0.85	CW	1.50	4.50	3/8
00504	OL50EMR2	50	230	0.85	CCW	1.50	4.50	3/8
00508(1)	OL50EM1B1	50	115	1.7	CW	2.89	4.50	5/16
00513	OL60EM2	50	208-230	1.2	CW	2.89	4.50	3/8

(1) 2 female spade terminals at end of each wire

ECM 51 Frame Commercial Refrigeration Motors



EM&S manufactures an ECM unit bearing construction motor that can serve as a drop-in replacement for the obsolete GE 55/44 frame ECM 1650 or 1850 rpm motor. This motor is available in a 9 watt and a 16 watt version. This promises substantial energy savings and potentially fast pay-back on the cost of conversion.



Features:

- Ultra high efficiency
- Improved reliability
- Enhanced airflow performance
- Energy savings of 66 percent over a wide speed range
- Low operating temperature
- Lyall plug or EMF plug
- Accessories included with each motor; (1) speed nut, (1) resilient fan silencer, (3) 8-36 mounting screws, (1) rainshield
- Replaces GE ECM 55/44 frame motors

Specifications:

- Totally enclosed air over
- Unit bearing
- 1/4" - 20 Threaded shaft
- 60/50 Hertz

ECM installation's average annual energy savings versus shaded pole motors

05443	\$ 35
05444	\$ 55

@ 8¢ KWH and 1.75 multiplier on energy saving

MARS NO.	WATTS	RPM	ROT OSE	VOLTS	AMPS	LEAD LENGTH
05443	9	1650	CW	115	0.32	12"
05444	16	1850	CW	115	0.40	12"

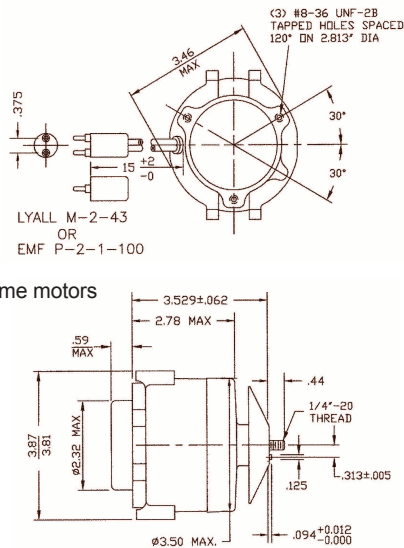

58 MM Series Replacement ECM Fan/Motor System

The 58MM Series replacement ECM Fan/Motor systems are primarily used in commercial refrigeration air moving applications demanding high efficiency and dependability. These motors are moisture resistant, reliable, quiet unit bearing design with efficiencies three times higher than shaded pole motors and 45% higher than PSC. These replacement ECM Fan/Motor systems are all metal in design and have 1 discrete speed, variable torque, low temperature lubrication system which makes them extremely quiet with low vibration.



Features:

- Lyall plug
- Class B insulation
- 60 Hertz
- Thermal protection
- Single phase

Specifications:

- -40 to 55°C ambient operating temp.
- Single speed
- Maximum watts 36

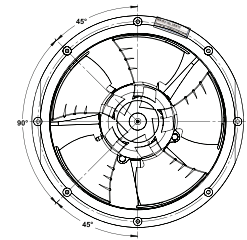

Front View

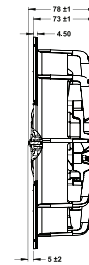

Side View

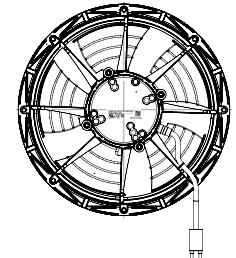

Rear View

MARS NO.	GE NO. 5SME58	REPLACES RPM	VOLTS	MAX AMPS	ROT. OSE	AT 0.05" CFM	AT 0.10" CFM	AT 0.15" CFM
05470	AAF1027	1340	115	0.30	CW	330	270	210
05471	AAF1026	1470	115	0.40	CW	370	300	200
05472	AAF1031	1650	115	0.40	CW	400	360	255

ECM Technology

These 51 frame unit bearing motors are primarily used in commercial refrigeration applications, both evaporator and condenser, but can be used in any application demanding high efficiency and dependability with output ratings between 4 – 12 watts and 13 – 23 watts.

These motors significantly outperform both shaded pole and PSC technology. With efficiencies three times higher than shaded pole motors and 45% higher than PSC, in addition to the reliable and quiet unit bearing design, they provide users great reliability and excellent energy savings for their applications



Environmental Summary:

- Storage Temps: -40 to 80° C ambient
- Operating Temps: -40 to 55° C ambient
- Design Life: 10 years, 83,720 hours on time

Mechanical Summary

- 3.3" Electronically commutated aluminum or cast iron unit bearing
- 1/4" x 20 threaded shaft
- Aluminum enclosure (totally enclosed)
- Five .150" diameter cored mounting holes on rear
- Horizontal shaft (+/- 15°) or vertical shaft up operating position
- Standard 18 gauge, 2 conductor leads
- Lead cord may be terminated with 1/2" stripped wire, in-house molded plugs, eyelets, 1/4" quick connects, or special terminals
- RoHS compliant

Applications:

- Bottle coolers
- Display cases
- Reach-In coolers
- Vending machines

Features:

- Output 4 – 12W and 13 – 23W
- ~66% peak efficiency
- Speed regulated within +/-6%
- Regulated speed; +/-6% Full Scale
- 1 Discrete speed
- 51fr Unit bearing motor; cast aluminum frame
- Side pedestal mounting feet (2 sets standard)

MARS NO.	APPLICATIONS	OUTPUT WATTS	VOLTS	ROT	RPM	MARS PACK
00650	Evaporator/Condenser	4-12	115	CW	1550	1
00651	Evaporator/Condenser	4-12	230	CW	1550	1
00652	Evaporator/Condenser (90° lyall plug)	4-12	115	CW	1550	1
00654	Evaporator/Condenser	13-23	115	CW	1550	1
00655	Evaporator/Condenser	13-23	230	CW	1550	1
00656	Evaporator/Condenser	13-23	115	CCW	1550	1
00657	Evaporator/Condenser	13-23	230	CCW	1550	1

ARKTIC™ 59

Ball Bearing

The Morrill ARKTIC 59 motor is primarily used in the evaporator of commercial refrigeration walk-in coolers and freezers, but can be used in any application demanding high efficiency and dependability with output ratings up to 50 watts. The ARKTIC 59 significantly outperforms both shaded pole and PSC technology with efficiencies three times higher than shaded pole motors and 40% higher than PSC. In addition to the reliable design, the ARKTIC 59 provides users the ease of drop-in replacement and extraordinary energy savings for their applications.

Features:

- Universal "Drop-In" replacement for walk-in evaporator applications
- Totally enclosed, non-vented
- Shaft water slinger
- Standard thru-bolt configuration
- All angle mount
- Power cord with lyall plug

Specifications:

- Automatic torque variation, constant speed
- Low temp (-20° F) lubrication system
- 50/60 Hz
- 1 Discrete speed
- CUL (CE & VDE pending) UL file # E306123
- Thermally protected



3.3 inch dia.

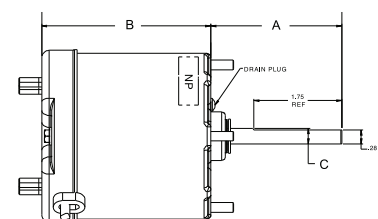

1550 RPM - Front Or Rear Thru-Bolt Mount

MARS NO.	MFG MODEL 5SME59	NOMINAL HP	VOLTS	AMPS	OSE ROT	DIMENSIONS		
						A	B	C
05105	BVA1038	1/15	115	1.1	CCW	2.61	3.36	5/16
05204	BVA2037	1/15	208-230	0.63	CW	2.61	3.36	5/16
05205	BVA2039	1/15	208-230	0.63	CCW	2.61	3.36	5/16

1550/800 RPM - Two Speed - Front or Rear Thru Bolt Mount

MARS NO.	MFG MODEL 5SME59	NOMINAL HP	VOLTS	AMPS	OSE ROT	DIMENSIONS		
						A	B	C
05127	BVA1065	1/15	115	1.1	CCW	2.61	3.36	5/16
05128	BVA1066	1/15	115	1.1	CW	2.61	3.36	5/16

MARS NO.	DESCRIPTION	MARS PACK
08040	Krack Refrigeration Retrofit Bracket Kit	1

Unit Bearing Motors / OEM Direct Replacement Motors

51 Frame Motors For Domestic Refrigeration



Features:

- Single phase, shaded pole
- Fan duty, continuous, air over
- Class A insulation
- 60/50 Hertz
- Impedance protected
- For accessories see pages M-44 – M-46



1550 RPM

MARS NO.	GE NO. 5KS	WATTS	ROT OSE	VOLTS	AMPS	SHAFT	REPLACES	MARS PACK
05109	M81FFL0065	2	CW	115	0.25	1/4-20 threaded	most refrigerators and freezers	12

Tyler Refrigeration OEM Direct Replacement Refrigeration Motors



Features:

- Universal 5 hole rear mount
- Dual mounting pads



MARS NO.	WATTS	VOLTS	RPM	AMPS	ROTATION	CONSTRUCTION	TYLER NO.
00660	5	115	1550	0.34	CW	cast iron	51255320
00661	9	115	1550	0.53	CW	aluminum	52434980

EM&S PSC Type Replacement For GE



Features:

- Drop-in replacement
- Single phase PSC
- Fan duty, continuous, air over
- Low temp oil
- Reliable unit bearing
- Internal capacitor

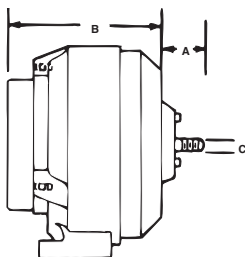

1660 RPM 1/4" – 20 Threaded

MARS NO.	GE NO. 5KS	WATTS	ROT OSE	VOLTS	AMPS	DIMENSIONS	
						A	B
00114	RS4BEB6E14	4	CW	115	0.20	0.40	2.50
00117*	RS4BEB9E12	9	CW	115	0.26	0.40	2.50

* 00117 replaces Hussmann SVC 441-302

11 Frame Unit Bearing Shaded Pole Motors



MARS unit bearing shaded pole motors are suitable for use in a wide variety of fan duty applications. Proven all-angle unit bearing design for trouble free operation. Can be resilient base, strap, or end mounted.



Features:

- All angle unit sleeve bearings
- Resilient base, strap, or end mounting
- 5/16 inch shaft diameter ground lead
- 12 inch leads
- For accessories see pages M-44 – M-46
- See the airMARS section of this catalog for fan blades & accessories

Specifications:

- Single phase, 60 Hertz
- Overload protection
- Fan duty, continuous, air over
- Shaft end has four 8-32 tapped holes
- UR/CSA

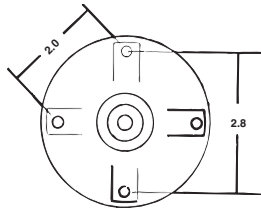
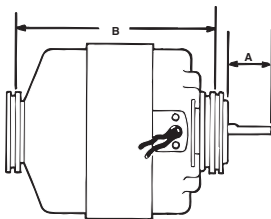

1550 RPM – 4 Pole

MARS NO.	GE NO. 5KSM92	HP	VOLTS	AMPS	ROT OSE	ENCL	DIMENSIONS		BASE NO.
							A	B	
01431	KFL2005S	1/30	115	1.74	CW	OPEN	1.25	4.82/4.70	08042
01441	KFL2003S	1/30	115	1.74	CCW	OPEN	1.25	4.82/4.70	08042
01432	KFL200(S)	1/20	208-230	0.76	CW	OPEN	1.25	4.82/4.70	08042
01442	KFL1009S	1/30	208-230	0.87	CCW	OPEN	1.25	4.82/4.70	08042
01332(1)	KFL2007S	1/20	208-230	1.1	CW	OPEN	2.00	4.82/4.70	08042
01232(2)(3)	KFL3006S	1/15	230	1.2	CW	OPEN	1.50	4.875	NONE

(1) 34 inch leads
 (2) 30 inch leads
 (3) 60/50 Hertz

NU Series Shaded Pole Motors



MARS is proud to introduce Elco NU Series shaded pole motors which are widely used in the HVAC & Refrigeration industry. These motors are suitable for all angle operation and have multiple mounting features. The NU series motors are used in industrial and commercial refrigeration for condensing and evaporating units, ventilating units, freezers, walk-in and reach-in coolers, food and beverage coolers and many other fan duty applications.



Features:

- Single speed
- Output 4 to 34 watts
- Totally enclosed
- Continuous air over
- 1 year Limited warranty

Specifications:

- Impedance or thermally protected
- All angle, sleeve bearing
- Class B insulation
- 50/60 Hz
- Standard operating temperature: -40°F to 104°F (-40°C to 40°C)
- 3 Tapped holes @ 120° & 2 @ 180°
- Single side pad mounting
- 4 Shaft end studs
- UL Recognized, CSA and CE Certified

MARS NO.	MFG STOCK NO.	WATTS	ROT. S.E	HP	VOLTS	AMPS	PROT.	BLADE DIA. IN.	BLADE PITCH	AIR FLOW (CFM) @ 0 IN. STATIC	AIR FLOW (CFM) @ .1 IN. STATIC
00805	EC6W115	6	CCW	1/125	115	0.41	Imp	7	31	206	119
00807	EC9W115	9	CCW	1/83	115	0.58	Therm	8	22	262	186
									28	325	240
00808	EC9W230				230	0.35		9	28	418	301
									28	476	395
00809	EC16W115	18	CCW	1/47	115	0.89	Therm	9	31	490	410
									34	557	466
									22	510	425
00810	EC16W230	16			230	0.50		10	28	610	470
									28	610	470
00817	EC34W115	34	CCW	1/20	115	1.6	Therm	12	19	796	697
00818	EC34W230				230	0.80			28	1024	785

Refrigeration Fan Motors

ECM High Efficiency Motors

MARS Hi Efficiency ECM motors are drop in replacements of the traditional front mount shaded pole motors. They use all the same accessories with no extra work for an easy and hassle-free installation. These are built with ECM technology to run more efficiently, reduced CO2 emissions, longer life expectancy and quieter than the normal PSC shaded pole motors. They offer better airflow control than a PSC, up to 70%, 4 to 5 times more efficient than a regular shaded pole motor. Higher efficiency means cooler motor operation and reduced heat delivered to the refrigeration cycle, for a combined energy saving advantage and improved refrigeration quality. The ECM Series offers IP65 moisture protection grade, one of the highest in the industry. These motors are designed to satisfy the growing demands of energy savings.



Features:

- Life expectancy of 60,000+ hrs.
- Protection rating - IP65 moisture protection grade
- Totally enclosed
- All angle
- Continuous air over
- Long life sealed ball bearings

Specifications:

- Working temp: -40°C +55°C
- 50/60 Hz
- M4 Studs on 3.72" B.C. for shroud/guard
- UL recognized & CE Certified

Cross Reference:

EDA15253UC0176, EDA10153UC0182	Hill Phoenix	P078449H, P079441C, P066237A
--------------------------------	--------------	------------------------------

MARS NO.	WATTS	VOLTS	RPM	ROT. S.E	AMPS	TERM.PLUG
00892	1-30	120/240	1600	CCW	0.7/0.4	2 pin Lyall



5KCP29 — Form G PSC Motors



Designed for virtually every fan and blower application.

Features:

- All angle sleeve bearings
- Open construction
- Aluminum end shields
- 26 inch color-coded leads
- 2-1/2 inch resilient ring mounting
- Double shaft models shipped with base mounted (3.5 inch shaft height)
- Extended thru bolts on shaft end—extended 3/4 inch on single shaft and 1-1/2 inch on double shaft motors (on 4.6 inch bolt circle)
- Energy Saver® design
- Motor reversing leads have terminals for quick change to opposite rotation
- For accessories see pages M-44 – M-46

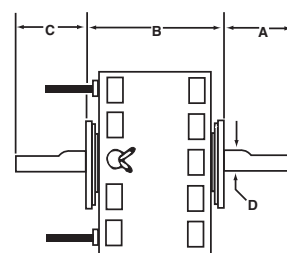
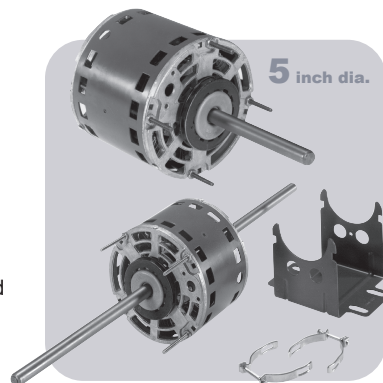

Specifications:

- Single phase, 60 Hertz
- Automatic reset overload protection
- Fan duty, continuous, air over
- Advanced Class B insulation
- 5 Mfd @ 370V capacitor required (MARS No. 12005)

MARS NO.	GE NO. 5KCP29	HP	VOLTS	AMPS	ROT LE	RPM	DIMENSIONS			
							A	B	C	D
1075 RPM - Single Shaft - Three Speed - 6 Pole										
02840(1)	BG5866S	1/30	115	.61	REV	1075	8.00	6.00/4.50	—	1/2
02824	EG5854S	1/8	115	2.45	REV	1075	4.00	5.06	—	1/2
02825	KG5855S	1/5	115	3.51	REV	1075	4.00	5.56	—	1/2
1075 RPM - Double Shaft - Four Speed - 6 Pole										
02830	BG5860S	1/15	115	1.4	CCW	1075	8.00	4.67	8.00	1/2
1625 RPM - Double Shaft - Four Speed - 4 Pole										
02837	FG5869S	1/6	115	2.1	CCW	1625	8.00	5.42	8.00	1/2

(1) Model has resilient ring length adapter kit included in carton

“Cap-Can” Construction Vertical Shaft Down Condenser Fan And Heat Pump Motors

Ball Bearing

These new permanent split capacitor motors from GE are designed for use in residential outdoor condenser fan and heat pump units (primarily up to 3.5 tons), requiring vertical shaft down with stud or flange mounting.

Features:

- “Cap-Can” construction
- Automatic thermal overload protection
- #8-32 extended stud or flange mount
- Water slinger on shaft
- Vertical shaft down mounting orientation
- CW or CCW rotation in several ratings
- Designed for 370 volt capacitor (not furnished)
- Class B insulation
- For accessories see pages M-44 – M-46

Specifications:

- All models are single-speed
- 60 Hz
- 208-230 Volts
- 1/2" Shaft diameter
- 26" Leads
- Continuous duty, air-over

MARS NO.	GE NO.	HP	RPM	AMPS	ROT OSE	370V CAP REQUIRED	DIMENSIONS		
							A	B	C
02248	5KCP29ECA328S	1/8	1075	0.86	CW	5 MFD	2.75	3.85	1/2"

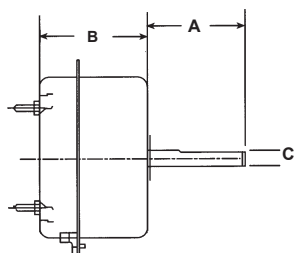

SOS™ Multi-Horsepower Direct Drive Blower Motors

MARS SOS™ multi-horsepower direct drive blower motors are ideal for truck stock. Four models cover both 115 volt and 208-230 volt applications from 1/6 through 3/4 HP.

All SOS™ motors feature easy mounting in Rheem applications.

Features:

- Multi-HP
- Open end shields
- Extended mounting studs
- 2-1/2 inch resilient rings
- Reversible rotation
- All angle sleeve or ball bearings
- Capacitor requirement noted on motor label
- For accessories see pages M-44 – M-46

Specifications:

- Single phase, 60 Hz
- Overload protection
- Fan duty, continuous air over
- Open construction

5 1/2 inch dia.

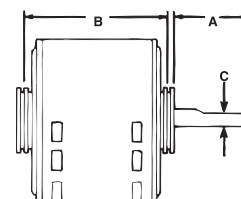
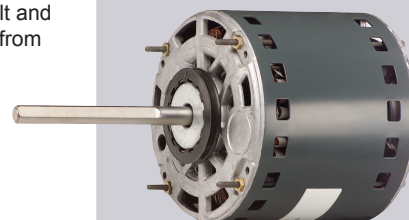

Cross Reference:

MARS No.	A.O. SMITH	EMERSON
03463	FDL6001	5460
03464	FD6000	5461
03466	FDL6002	5470

1075 RPM Multi-Horsepower Reversible Rotation – 6 Pole

MARS NO.	GE NO. 5KCP39	HP	VOLTS	AMPS	DIMENSIONS		
					A	B	C
03463	KGV804AS	1/2, 1/3, 1/4, 1/5, 1/6	115	6.2	5.00	4.73	1/2
03464	KGV805AS	1/2, 1/3, 1/4, 1/5, 1/6	208-230	2.7	5.00	4.73	1/2
03466*	SGU363AS	3/4, 1/2, 1/3, 1/4, 1/5	115	8.4	5.00	5.98	1/2

* Ball Bearing

SOS™ Multi-Horsepower Outdoor Condenser Fan Motors

Ball Bearing

MARS SOS™ multi-horsepower condenser fan motors are ideal for truck stock. Three 1075 RPM models cover 208-230 volt applications from 1/6 to 1/2 HP.

New Slim Stack™#03458, **WIZARD**, and the new **WIZARD 825** fit in many 1/3 HP installations that will not accept other manufacturer's motors.

The 03458 is a single speed "wide-range" motor that will run at any fan load from 1/6 to 1/3 HP at a nominal 1075 RPM. MARS #03459, the new WIZARD 825, will run at any fan load from 1/8 to 1/3 HP at a nominal 825 RPM.

All SOS™ motors feature easy mounting in Rheem applications.

Features:

- Multi-HP
- Thru bolt or band mounting
- Rheem mounting capability
- Water slinger on shaft
- Air conditioning or heat pump duty
- Capacitor requirement noted on motor label
- End Shield drain holes w/plugs

Specifications:

- Single phase, 60 Hz
- Overload protection
- Fan duty, continuous air over
- Totally enclosed, Non-ventilated
- Class B insulation

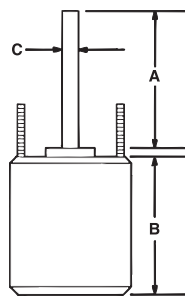

* Heat Shield

Cross Reference:

MARS No.	A.O. SMITH	EMERSON
03458	ORM5458	5458
03459	ORM5488B	5464
03468	FE6002	5465
03469	FE6001	5464

Multi-Horsepower, Reversible Rotation

MARS NO.	GE NO. 5KCP39	HP	VOLTS	AMPS	DIMENSIONS			
					A	B	C	
1075 RPM - 6 Pole								
03458	Wizard	JGU530S	1/3, 1/4, 1/5, 1/6	208-230	2.8	6.75	4.48	1/2
03458HS*	Wizard	LGU7215	1/3, 1/4, 1/5, 1/6	208-230	2.6	6.50	5.23	1/2
825 RPM - 8 Pole								
03459*	Wizard 825	NFBA87S	1/3, 1/4, 1/5, 1/6, 1/8	208-230	1.8	6.50	5.48	1/2

* Heat Shield

Vertical Outdoor Condenser Fan Motors Shaft-Up/Down

Ball Bearing

GE up/down outdoor condenser fan motors are designed for either vertical shaft-up or shaft-down applications. Shell and end shields are enclosed for weather protection. A weep hole is provided in each end shield to allow condensate to drain. A plastic plug is provided to seal the weep hole in the end shield exposed to the weather. All of these motors are suitable for air conditioning or heat pump applications. All feature reversible rotation, 208-230 volts, six inch shaft length and extended thru bolts extending from both ends.

Features:

- Thru bolt or band mounting
- All angle mounting
- Water slinger on shaft
- Serrated end cap on shaft end only
- For air conditioning or heat pumps
- Full six inch shaft length with two full flats at 90°
- Reversible rotation
- For accessories see pages M-44 – M-46
- Rheem mtg. holes (mtg. hardware included)

Specifications:

- 60 Hertz
- Single phase
- Overload protected
- Fan duty, continuous, air over
- 48 inch leads
- Totally enclosed, non-ventilated
- Class B insulation

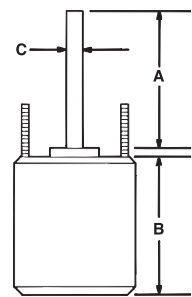

* Heat Shield

Reversible Rotation

MARS NO.	GE NO. 5KCP39	HP	VOLTS	AMPS	RPM (1)	CAP REQ.	DIMENSIONS		
							A	B	C
825 RPM - Single Speed - Standard Efficiency - 8 Pole									
03203*	HFBA79S	1/6	208-230	0.90	825	5/370	6.0	4.30	1/2
03204*	JFBA83	1/4	208-230	1.3	825	7.5/370	6.0	5.03	1/2
03205*	NFBA82S	1/3	208-230	1.8	825	10/370	6.0	5.80	1/2
1075 RPM - Single Speed - Standard Efficiency - 6 Pole									
03733(2)*	LGU715S	1/3	208-230	2.6	1075	7.5/370	6.0	4.48	1/2
03734(2)*	RGU718S	1/2	208-230	3.0	1075	10/370	6.0	5.23	1/2
03735(2)*	SGU717S	3/4	208-230	4.1	1075	10/370	6.0	5.98	1/2

(1) Low speed approximately 300 RPM less than high speed depending on fan load

* Heat Shield

Shaft-Up Outdoor Condenser Fan Motors



GE outdoor condenser fan motors for vertical shaft-up applications are also suitable for horizontal mounting. GE vertical shaft-up outdoor condenser fan motors are designed for 60°C ambient temperature. Add MARS No. 08105 resilient rings to base mount.

GE commercial 460 volt outdoor condenser fan motors are designed for 70°C ambient so lower operating temperatures = improved life and reliability.

5 1/2 inch dia.

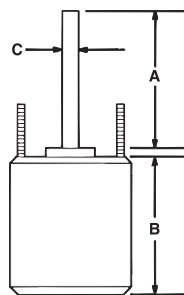

Features:

- Reversible rotation
- Thru bolt or band mounting
- Water slinger on shaft
- Serrated end caps on vertical shaft-up models
- Full six inch shaft length
- For accessories see pages M-44 – M-46

Specifications:

- Class B insulation
- Single phase, 60/50 Hertz
- Automatic thermal overload protected
- Fan duty, continuous, air over
- 26 inch leads shaft-up, 46 inch leads all angle
- Lead end endshield open construction



* Heat Shield

Reversible Rotation

MARS NO.	GE NO. 5KCP39	HP	VOLTS	AMPS	RPM	CAP REQ.	DIMENSIONS		
							A	B	C

1075 RPM - Shaft-Up - Single Speed - Sleeve Bearings - Standard Efficiency - 6 Pole

03329 ⁽¹⁾⁽²⁾	HGP698S	1/3	208-230	2.4	1075	7.5/370	6.0	5.31	1/2
03330 ⁽¹⁾⁽²⁾	MGK209S	1/2	208-230	3.6	1075	10/370	6.0	6.60	1/2
03331 ⁽¹⁾⁽²⁾	PFM210S	3/4	208-230	5.1	1075	10/370	6.0	6.06	1/2

1075 RPM - 460V - Single Speed - All Angle Ball Bearing - 6 Pole

03737 ^{(1)(3)*}	NGU724S	1/3	460	1.2	1075	7.5/370	6.0	5.30	1/2
03738 ^{(1)(3)*}	RGU723S	1/2	460	1.7	1075	10/370	6.0	5.80	1/2
03739 ^{(1)(3)*}	SGU725S	3/4	460	2.0	1075	15/370	6.0	6.50	1/2

(1) 60 Hertz only

(2) Class A Insulation

(3) Rheem shell mtg. holes

* Heat Shield

5KCP39 PSC 460 Volt Motors

Ball Bearing

Features:

- Energy Saver®
- For use in air moving applications
- 460 volt, 2-speed
- All angle
- Extended thru bolts
- Capacitor included
- 08105 for cradle mount, serrated end caps
- For accessories see pages M-44 – M-46

Specifications:

- Single phase, 60/50 Hz
- Overload protection
- Fan duty, continuous, air over
- Enclosed shell, open end shields
- 26 inch leads
- Class A insulation

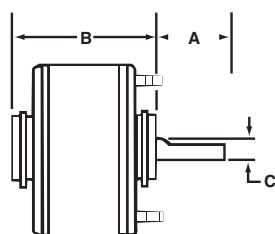
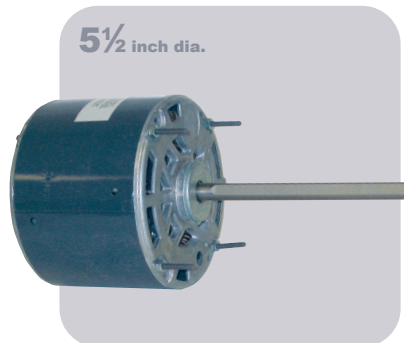

1075 RPM – Reversible Rotation - 6 Pole

MARS NO.	GE NO. 5KCP39	HP	VOLTS	AMPS	CAP. (FURNISHED)	DIMENSIONS			BASE NO.
						A	B	C	
03290	PGC520ET	3/4	460	2.1	15/370	6.0	6.31	1/2	08060



PSC Direct Drive Blower Motors



These GE 5KCP39 PSC motors are designed for use as direct drive furnace blower motors. All are three speed, high efficiency, Energy Saver® models and are electrically reversible. Motors have 2-1/4 inch resilient rings for base mounting. Four (4) split rings included if 2-1/2 inch diameter is required. Bases are sold separately.

Features:

- All angle sleeve bearings
- 3 speeds
- 1/2 inch extended thru bolts
- Ring kit allows 2-1/4 inch & 2-1/2 inch resilient ring mounting
- Reversible rotation
- 4 inch long, 1/2 inch diameter shaft
- For accessories see pages M-44 – M-46

Specifications:

- Single phase, 60/50 Hertz
- Overload protection
- Fan duty, continuous, air over
- Open construction
- 26 inch leads
- Class B insulation

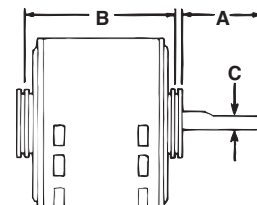

Reversible Rotation — Energy Saver®

MARS NO.	GE NO. 5KCP39	HP	VOLTS	AMPS	CAP. REQ.	DIMENSIONS			BASE NO.
						A	B	C	
03999	PGE416T	3/4	208-230	4.0	7.5/370	4.0	6.14	1/2	08060

1625 RPM⁽¹⁾ — Three Speed - 4 Pole

1075 RPM — Reversible Rotation - Standard Efficiency - 6

MARS NO.	GE NO. 5KCP39	HP	VOLTS	AMPS	CAP. REQ.	DIMENSIONS			BASE NO.
						A	B	C	
Three Speed⁽¹⁾									
03583 ⁽²⁾	FGN651T	1/4	115	4.2	5/370	4.0	4.89	1/2	08055
03586 ⁽²⁾	JGN654T	1/3	208-230	2.9	5/370	4.0	5.14	1/2	08056
03587 ⁽²⁾	PGN655T	1/2	115	9.0	5/370	4.0	6.14	1/2	08060
03588 ⁽²⁾	NGN656T	1/2	208-230	4.3	5/370	4.0	5.89	1/2	NA
03595 ⁽²⁾	SGL854S	1	115	11.8	20/370	4.0	6.90	1/2	08060
Two Speed⁽³⁾									
03383 ⁽²⁾	FGM421S	1/4	115	4.2	5/370	4.0	4.89	1/2	08055
03387	PGM438S	1/2	115	9.0	5/370	4.0	6.14	1/2	08060
03389	PGN091T	3/4	115	10.3	15/370	4.0	6.14	1/2	08060

(1) Approximately 150RPM differential between speeds depending on fan load

(2) 60 Hz only

(3) Approximately 300RPM differential between speeds depending on fan load

5KCP39 PSC Torsion Flex Mount Motors



GE torsion-flex mount motors are designed for direct drive furnace blower applications. The unique torsion-flex mounting speeds installation while the special steel of the torsion-flex bracket absorbs vibration for quieter operation. All models are electrically reversible, 3-speed motors of high efficiency Energy Saver® design.

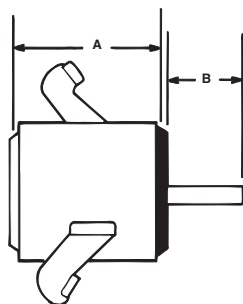
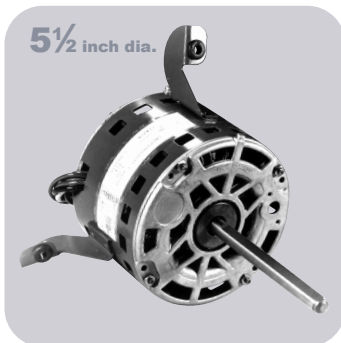

Features:

- Energy Saver®
- All angle sleeve bearings
- 3-Speed 1075/925/775 RPM⁽¹⁾
- Torsion-flex mounting, grommets and sleeves included
- 5.0 inch long, 1/2 inch diameter shaft
- Reversible rotation

Specifications:

- Class A insulation
- Single phase, 60/50 Hertz
- Overload protection
- Fan duty, continuous, air over
- Open construction
- 26 inch leads

1075 RPM⁽¹⁾ — Three Speed – Reversible Rotation - 6 Pole

MARS NO.	GE NO. 5KCP39	HP	VOLTS	AMPS	CAP. REQ.	DIMENSIONS		BLOWER SIZE
						A	B	
03785 ⁽²⁾	LGP732S	1/3	115	4.9	7.5/370	5.0	4.98	9 in.
03786	JGP733S	1/3	208-230	2.5	5/370	5.0	4.73	9 in.
03787	PGP734S	1/2	115	7.3	10/370	5.0	5.48	10 in.

⁽¹⁾ Approximately 150RPM differential between speeds depending on fan load
⁽²⁾ 60 Hz only

PSC Motors Replace 5KCP32 & 5KCP38



Features:

- Energy Saver®
- Replace GE 5KCP32-38
- All angle sleeve bearings
- Two-speed, 1075/775 RPM(2) double shaft
- Extended thru bolts, base included, plus 4 split rings
- 14 inch leads
- For accessories see pages M-44 – M-46

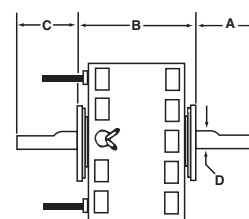
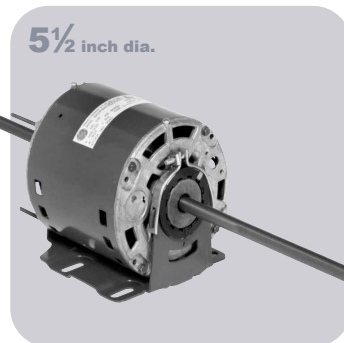

Specifications:

- Single phase, 60/50 Hertz
- Open construction
- Overload protected
- Fan duty, continuous, air over
- 3 inch shaft height when base mounted

1075/775 RPM⁽¹⁾

MARS NO.	GE NO. 5KCP	HP	VOLTS	AMPS	ROT LE	CAP. REQ.	DIMENSIONS			
							A	B	C	D
03092 ⁽²⁾	39NGD369T	1/2	208-230	3.8	CCW	5/370	8.00	6.46	8.50	1/2

⁽¹⁾ Approximately 300 RPM differential between speeds depending on fan load
⁽²⁾ 60 Hertz only

5KCP39 PSC Double Shaft Motors



GE Commercial Motors

By Regal-Beloit

Features:

- All angle sleeve bearings
- 3 speed, 1075/925/775 RPM
- Extended thru bolts
- Base mount using mounting kit 08095 and appropriate base
- Double 1/2 inch diameter shafts
- For accessories see pages M-44 – M-46

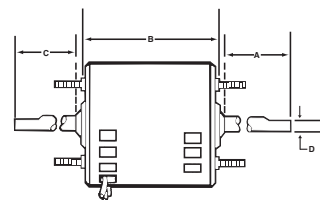
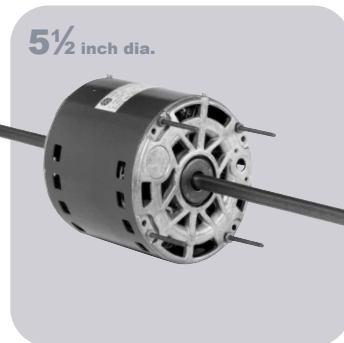

Specifications:

- Single phase, 60/50 Hertz
- Overload protected
- Fan duty, continuous, air over
- Open construction
- Requires 5 mfd, 370 volt capacitor (MARS No. 12005)
- 14 inch numbered leads

1075/925/775 RPM⁽¹⁾

MARS NO.	GE NO. 5KCP39	HP	VOLTS	AMPS	RPM ⁽¹⁾	ROT LE	DIMENSIONS				BASE NO.
							A	B	C	D	
03696	NGA407T	1/2	208-230	3.5	1075/975/775	CCW	7.50	5.25	7.25	1/2	08060

⁽¹⁾ Approximately 150 RPM differential between speeds depending on fan load

GE TECMate Pro™ Service Tool



The Tecmate Pro™ Service Tool, MARS stock #08500 is the latest advance in ECM technology developed by and for Genteq Motors. The Tecmate allows the service technician to analyze a Genteq ECM motor independently of the HVAC system in which it is installed. The Tecmate can test all the basic settings of a Genteq ECM motor, and can detect and isolate motor failures from HVAC system failures.

Compact

Easy To Use



MARS NO.	DESCRIPTION
08500	TECMate Pro ECM Motor Tester

Broad Ocean ECM Motor Tester (Digimotor Test Tool)

Save time and money with the Broad Ocean ECM Motor Tester

- Isolates any issues to either the motor or the control board and the control wiring

NOTE: This tool is for Broad Ocean OEM Digi-Motors only.

This tool is not compatible with Azure®.

Kit Contents:

- Broad Ocean ECM Tool
- Type A test Connector (Furnaces, AH & Packaged)
- Type B Test Connector (Packaged Units)
- Type C Test Connector (Air Handlers)
- Type D Test Connector (Outdoor Condenser Fan Motors)



MARS NO.	DESCRIPTION	MARS PACK
08503	Broad Ocean ECM Motor Tester	1

ECM Protectors

Saves Equipment

ECM protectors plug into existing motor connectors or plugs. They help to protect these valuable motors from voltage spikes, surges, and transients that often damage them.

Fast Installation

These protectors simply plug in between the motor connector and the existing wiring harness. A ground strap with a ring terminal is provided for additional protection.

Protect Your Investment

The most common cause of ECM motor failure is damage to the electronics module as a result of poorly conditioned incoming power.

MARS NO.	USED ON	MARS PACK
08552	GE X-13 ECM	1
08553	OEM ECM Applications	1



ECM Repair Kit

Repairs many ECM motor modules that have been damaged by voltage problems and power surges

- Full instructions included in kit
- Kit includes **OCPD** device and helpful circuit board releaser tool
- Using the kit requires a soldering gun or iron and rosin core solder

ECM's have ***Over Current Protection Devices** that are designed to keep excessive power from damaging other system components. Frequently, only this part needs replacement to restore an expensive ECM to an operation condition.

Not every ECM module can be repaired. Because of this, the repair kit is not guaranteed to fix every motor-but because of the motor's high cost vs. the repair kit's low cost- it's often worth the effort.

MARS NO.	DESCRIPTION	MARS PACK
08551	ECM Repair Kit	1



Variable Speed Zebra



Complete diagnostics for systems where an ECM motor is not working properly

Uses simple-to-operate microprocessor controlled tests to:

- accurately diagnose exactly which component has failed in a variable speed system that is not working correctly
- assist in system setup by reporting CFM airflow and motor RPM as room vents and other controls are adjusted
- allows easy adjustment of all available settings and options on ECM blower motors to obtain maximum customer comfort



MARS NO.	DESCRIPTION	MARS PACK
08550	ECM Diagnostic System	1
08562	2 Pc Adapter Set for New GE X-13 & Evergreen Motors (Variable Speed)	1

Universal Zebra



A tool designed to troubleshoot every ECM motor in HVAC/R systems!

- Three 3-position switches test up to 6 speeds
- LED's indicate power and signals being sent
- Rugged case protects your tools & leads

Adapters for Universal Zebra

- Adapters quickly plug into motor and Universal Zebra
- Magnetic reference cards show what each switch does & what each LED means for that motor



MARS NO.	DESCRIPTION	MARS PACK
08554	Universal ECM Diagnostic System	1

MARS

08555 Adapter "A" – for GE 2.0 & 2.3 ECM's

08556 Adapter "B" – for Genteq 3.0 ECM's

08557 Adapter "C" – for X-13 & X-mtr ECM's

08558 Adapter "E" – for ECM 142 & Signal Select ECM's

Motor Mounting Bases

Designed for use with GE motors. Bases include clips.

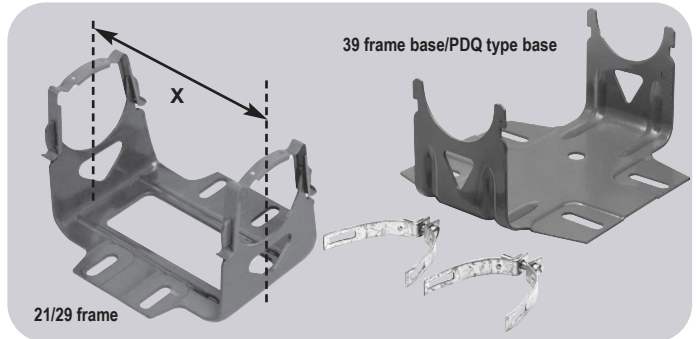

Mounting Bases

MARS NO.	FOR USE ON	GE NO.	SHAFT HEIGHT	X DIMENSION
08060	39 frame motors	920AB10	3-1/2	5.98/6.14

Mounting Accessories

MARS NO.	USED ON	DESCRIPTION	PAK QUAN
08096	39 frame	clips for 39 frame motor bases	2 pieces

Vibration Insulators

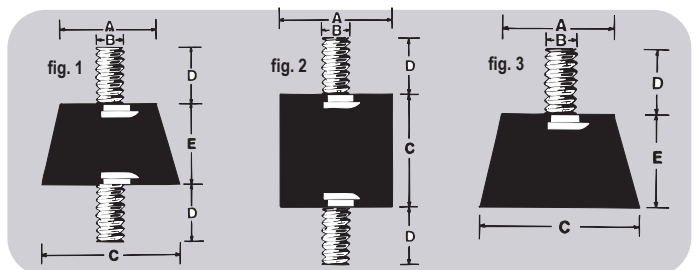

MARS NO.	MFR. NO.	DIMENSIONS					MAX. LOAD IN POUNDS			FIG. NO.
		A	B	C	D	E	THD.	COMPRESSION	SHEAR	
07801	K30	1-3/16	5/16	1-5/8	5/8	1-1/2	18	60	-	1
07802	K33	1-3/8	5/16	1-5/8	5/8	1.0	18	100	-	1
07804	K44	1.0	5/16	1.0	5/8	-	18	40	10	2
07805	K47	1.0	1/4	3/4	1/2	-	20	50	10	2
07807	K133	1-3/8	5/16	1-5/8	5/8	1.0	18	100	-	3

Plastic Rain Shields



MARS NO.	DESCRIPTION	MARS PACK
93581	6-3/4 in. diameter for motors with 1/2 in. diameter shaft	1 piece
93582	6-3/4 in. diameter for motors with 5/8 in. diameter shaft	1 piece

Mounting Brackets

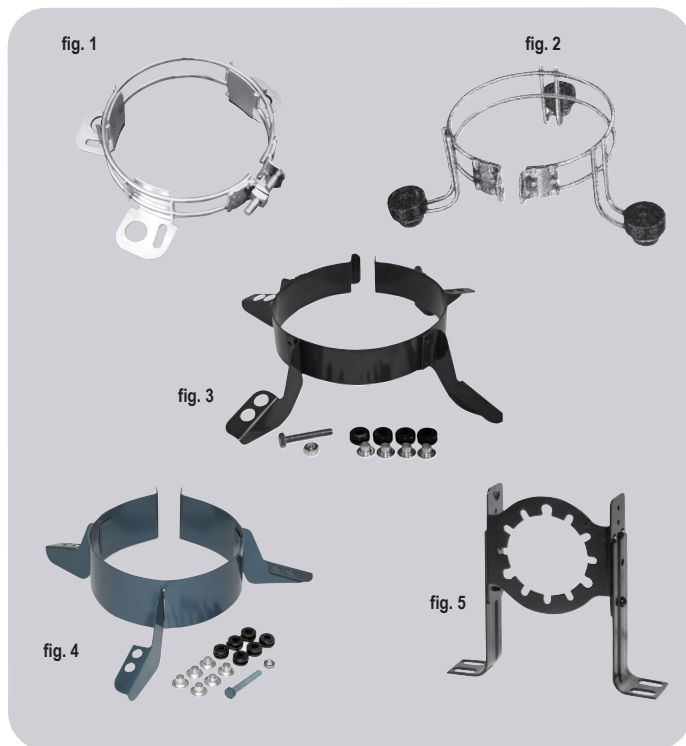

MARS NO.	USED ON	DESCRIPTION	FIG. NO.
08020	39 frame and 5-1/2 in. diam. motors	adj. lug mounting bracket fits triangular bolt patterns of 6-1/8 in. to 6-9/16 in. bolt to bolt (1/4 in. x 7/8 in. and 3/4 in. x 1-3/8 in. knockouts)	1
08021	5-1/2 in. fixed motor mtg. bracket with grommets	for mounting blower motor with large wheel opening fits any 5-1/2 in. diameter motor	2
08024	5 in. fixed motor mtg. bracket with grommets	for mounting blower motor with large wheel opening fits any 5 in. diameter motor	2
08049	29 and 39 frame motors, 5 in. motors	3 Wing Torsion-Flex mounting adapter kit for 9 in. and 10 in. blowers	4
08050	48 frame, 5-5/8 in. and 5-1/2 in. diam. motors	3 Wing Torsion-Flex mounting adapter kit for 9 in. and 10 in. blowers	4
08047	48 frame, 5-5/8 in. and 5-1/2 in. diam. motors	4 Wing Torsion-Flex mounting adapter kit for 9 in. and 10 in. blowers	3
08004	51 frame motors	shaft height adjustable 4-1/8 in. to 5-3/8 in.	5

Premium Belly Bands

Applications:

Residential HVAC,
Direct Drive Blowers

- Welded 3-ring bracket
- Anodized steel rod construction
- Includes 3 sets of rubber grommets, 3 sheet metal screws, 3 galvanized steel sleeves, 1 bolt, 1 nut



MARS NO.	DESCRIPTION
08025	10" Bolt Pattern
08026	11" Bolt Pattern

Applications:

Residential HVAC,
Direct Drive Blowers

- Welded 4-ring bracket
- Anodized steel rod construction
- Includes 4 sets of rubber grommets, 4 sheet metal screws, 4 galvanized steel sleeves, 1 bolt, 1 nut



MARS NO.	DESCRIPTION
08027	13" Bolt Pattern

Rheem Adapter Belly Bands

Applications:

Rheem Blower Assemblies

This kit allows the use of standard 5.5" blower motors (without Rheem mounting holes) in Rheem original equipment blower applications.

- Welded 4-ring bracket
- Anodized steel rod construction
- Includes bracket, blower housing tabs, hardware & grommets



MARS NO.	DESCRIPTION
08028	Rheem Adapter